



we build trust

bathroom solutions

Каталог

Решения для ванных комнат

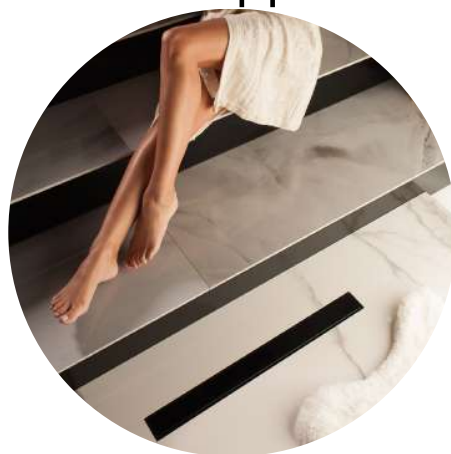

По вопросам продаж и поддержки обращайтесь:

Алматы (7273)495-231
Ангарск (3955)60-70-56
Архангельск (8182)63-90-72
Астрахань (8512)99-46-04
Барнаул (3852)73-04-60
Белгород (4722)40-23-64
Благовещенск (4162)22-76-07
Брянск (4832)59-03-52
Владивосток (423)249-28-31
Владикавказ (8672)28-90-48
Владимир (4922)49-43-18
Волгоград (844)278-03-48
Вологда (8172)26-41-59
Воронеж (473)204-51-73
Екатеринбург (343)384-55-89

Иваново (4932)77-34-06
Ижевск (3412)26-03-58
Иркутск (395)279-98-46
Казань (843)206-01-48
Калининград (4012)72-03-81
Калуга (4842)92-23-67
Кемерово (3842)65-04-62
Киров (8332)68-02-04
Коломна (4966)23-41-49
Кострома (4942)77-07-48
Краснодар (861)203-40-90
Красноярск (391)204-63-61
Курск (4712)77-13-04
Курган (3522)50-90-47
Липецк (4742)52-20-81

Магнитогорск (3519)55-03-13
Москва (495)268-04-70
Мурманск (8152)59-64-93
Набережные Челны (8552)20-53-41
Нижний Новгород (831)429-08-12
Новокузнецк (3843)20-46-81
Ноябрьск (3496)41-32-12
Новосибирск (383)227-86-73
Омск (3812)21-46-40
Орел (4862)44-53-42
Оренбург (3532)37-68-04
Пенза (8412)22-31-16
Петрозаводск (8142)55-98-37
Псков (8112)59-10-37
Пермь (342)205-81-47

Ростов-на-Дону (863)308-18-15
Рязань (4912)46-61-64
Самара (846)206-03-16
Санкт-Петербург (812)309-46-40
Саратов (845)249-38-78
Севастополь (8692)22-31-93
Саранск (8342)22-96-24
Симферополь (3652)67-13-56
Смоленск (4812)29-41-54
Сочи (862)225-72-31
Ставрополь (8652)20-65-13
Сургут (3462)77-98-35
Сыктывкар (8212)25-95-17
Тамбов (4752)50-40-97
Тверь (4822)63-31-35

Тольятти (8482)63-91-07
Томск (3822)98-41-53
Тула (4872)33-79-87
Тюмень (3452)66-21-18
Ульяновск (8422)24-23-59
Улан-Удэ (3012)59-97-51
Уфа (347)229-48-12
Хабаровск (4212)92-98-04
Чебоксары (8352)28-53-07
Челябинск (351)202-03-61
Череповец (8202)49-02-64
Чита (3022)38-34-83
Якутск (4112)23-90-97
Ярославль (4852)69-52-93

Россия +7(495)268-04-70

Казахстан +7(7172)727-132

Киргизия +996(312)96-26-47

почта: pad@nt-rt.ru || сайт: <https://pestan.nt-rt.ru/>

WE ARE

The Pestan company is a leader in the Balkans in the production and distribution of polymer products and solutions. Our mission is to improve the quality of life with the help of reliable products and solutions since 1989. Today, over 8,500 products can be found in the offer, divided into two categories: pipe and bathroom solutions. We are present in over 80 countries of the world, through a global network of agents and distributors.



**PIPING
SOLUTIONS**



**BATHROOM
SOLUTIONS**

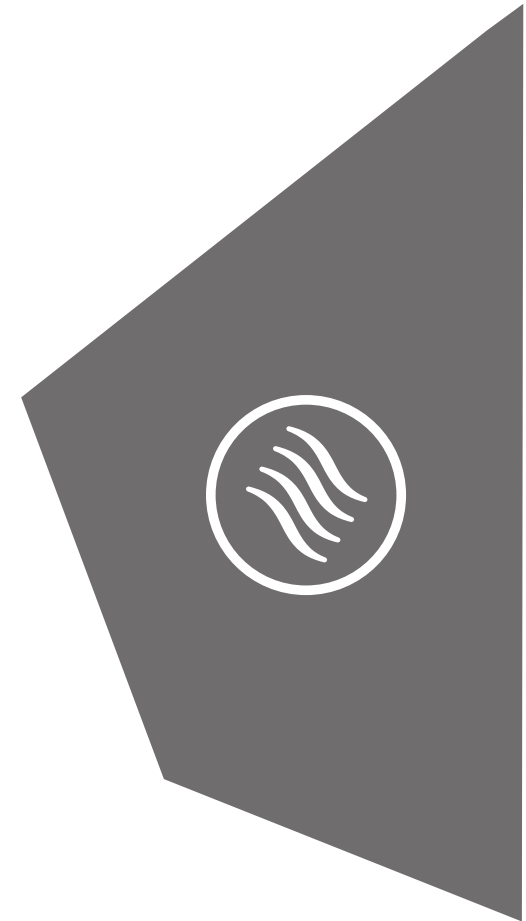

Jun 2024.

Production facilities of company Peštan are located in Arandjelovac, Serbia. Annual revenue exceeding 150 million €, which is realized with the help of 1.200 employees. Peštan has a direct presence, through its daughter companies, in Bosnia and Herzegovina, as well as in Romania and through its representative offices in Albania, Croatia and the United Arab Emirates. Peštan operates in more than 80 countries worldwide through a global network of agents and distributors. Primarily export-oriented, the company is present in the market of Europe, Russia, Middle East, North Africa, Latin America and the United States. The entire production is adjusted to European standards which is proved by international certificates for quality products:

IGH, Bulgarkontrola, INSTA-CERT-DANCERT, MPA, DVGW, ITC, EBETAM, EMI, GOST, ICC, IAMPO, KIWA, SKZ, SPSC, VUPS, VUSAPL, BENOR, BELNIIS, HESSEL, TZW, FRAUNHOFER, CSI, MIRTEC and certificates of quality process ISO 9001, ISO 14001, ISO 45001, ISO/IEC 27001, ISO 50001. For maximum satisfaction of customer needs, the company is constantly innovating and improving personnel and equipment. Since 2009, the company introduced the SAP ERP modules MM, SD, PP, FI CO, and since 2012 have extended functionality and WMS was included. The introduction of WCM and WMS system has increased the efficiency, contributed to the allocation of costs and professional maintenance. Central warehouse is located in Serbia, Arandjelovac, which is sized

and designed to meet the requirements of the most demanding customers who want efficient and reliable delivery of products. To respond to these requirements, Peštan has 15.000 m² of closed storage space for finished and semi-finished products, 10.000 m² warehouse for raw materials and intermediate goods, and approximately 150.000 m² of open storage space. Our vision is to be recognized as a leader in the Balkans, which provides customers with diversified solutions and products in one place. Our mission is creating a competitive advantage in our customers' businesses with the help of first-class solutions, services and products. We provide our company's success by consistently meeting the needs of clients, stakeholders and employees.

A hand holding a wooden house-shaped keychain in a workshop setting. The background is a blurred workshop with various tools and materials.

KEY FACTS

80
AND MORE
COUNTRIES
WHERE WE EXPORT
OUR PRODUCTS

8.500
DIFFERENT PRODUCTS
IN OUR PRODUCTION
ASSORTMENT

65.000
TONS OF MATERIAL
PROCESSED
ANNUALLY

BATHROOM SOLUTIONS

Peštan bathroom solutions program contains 2 product groups under two brands: Confluo shower drains, Fluenta build-in cisterns, and Fluenta toilet bowls.

Confluo is a shower drain brand that has been recognizing Peštan company as a globally well-known drainage expert in the bathroom industry for a long time.



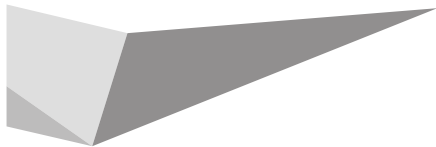









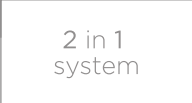

Fluenta build-in cistern and toilet bowls are the newest product in our bathroom portfolio and represent our desire to offer complete and top quality solutions for the bathroom.



PEŠTAN
CONFLUO
SMART DRAINS



Confluo icons

- | | | | | |
|--|--|--|---|---|
| <p>1</p>  <p>Min. installation height
Minimal construction height of drain, from bottom of the base, up to the holder.</p> | <p>2</p>  <p>Base diameter outlet
Diameter of base outlet.</p> | <p>3</p>  <p>Maximum flow rate
Maximum flow rate with 20 mm threshold.</p> | <p>4</p>  <p>Base inlet diameter
Diameter of base inlet.</p> | <p>5</p>  <p>Anti-leaking system
Anti-Leaking System represents combination of drain construction and proper installation which allows all leaked and condensated water to go back to drain.</p> |
| <p>6</p>  <p>2 in 1 system
Grid of drain can be turned and used both for stainless steel/gold and ceramic/glass finish.</p> | <p>7</p>  <p>Base rotation
Base of drain can be rotated 360°</p> | <p>8</p>  <p>Fine output adjustment
Output of drain can be adjusted by 15°.</p> | <p>9</p>  <p>Water seal height</p> | <p>10</p>  <p>Fine ceramic adjustment
Model have system for ceramic height leveling, so clients have flexibility in choosing surface in bathroom.</p> |
| <p>11</p>  <p>Self-cleaning base
The output of drain is constructed in a way that whatever goes through the grid for hair will also go through output for sure, and then through the sewage system.</p> | <p>12</p>  <p>Handicapped accessible
Easy access to the shower.</p> | <p>13</p>  <p>Material of grid
Grid is made of stainless steel AISI 304. Optionally, we can produce grid from stainless steel AISI 316.</p> | <p>14</p>  <p>Load class of grid
Grid is classified as K3, which means that it can withstand 300 kg of pressure.</p> | <p>15</p>  <p>Ceramic adjustment
Unlimited ceramic height leveling.</p> |

Confluo Linear drains

We produce our Confluo Linear drains in 4 different models (Premium Line, Compact Line, Slim Line and Frameless Line), 9 different sizes (300, 450, 550, 650, 750, 850 and 950 mm) and 4 different grid finishes (Stainless Steel, Black Matte, Glass and Gold). All models, except Slim, have 2 in 1 system where the same model can be used both with Stainless Steel/Gold and Tile/Glass finish and are characterized as ultra low 360 degrees rotatable self-cleaning S base.



Confluo Wall drain

As Peřtan Company always follows trends on world market, we have prepared for our customers the latest model in world of shower drains – Wall drain. This model represents innovation in industry and, besides its new and modern design, it is perfect model for renovations and bathrooms with concealed cisterns. Wall drain has body made of plastic and it is supplied with 2 different grids (Stainless Steel and Gold).



Confluo Board

Peřtan “Board” program of preinstalled shower drains represents the result of constant searching for better and more efficient solutions for our customers worldwide. With this product, we made a big step ahead concerning waterproofing, safety and aesthetics, as we have minimized possibility of mistake and significantly reduced the time and effort for installation. With this product, as a producer, we have taken responsibility on our side and made modern, quality and time effective solutions for our clients.



Confluo Standard drains

Peřtan Company offers to clients more than 150 different models of Confluo Standard drains. All models have body made of plastic and grid made of stainless steel, glass or gold, which we possess in various designs (Tide, Square, Drops, Plate 2 in 1, Black & White Glass, Ceramic and Gold) and sizes (10x10 cm, 15x15 cm and 20x20 cm). Main advantages are: Big variety of models, maximum flow rate, modular and flexible systems with 6 different outputs, 3 different types of siphons. You can make your own floor drain system easy for installation and maintenance.





Ultra low S base

Main advantages:

1. 360° rotation
2. Superior flow rate — 48 l/min
 - DN 50 mm output
3. Ultra low — 50 mm
4. Acute angle of siphon — 40°
5. Self-cleaning
 - Smooth plastic
 - Wide channel for water, without any obstacles

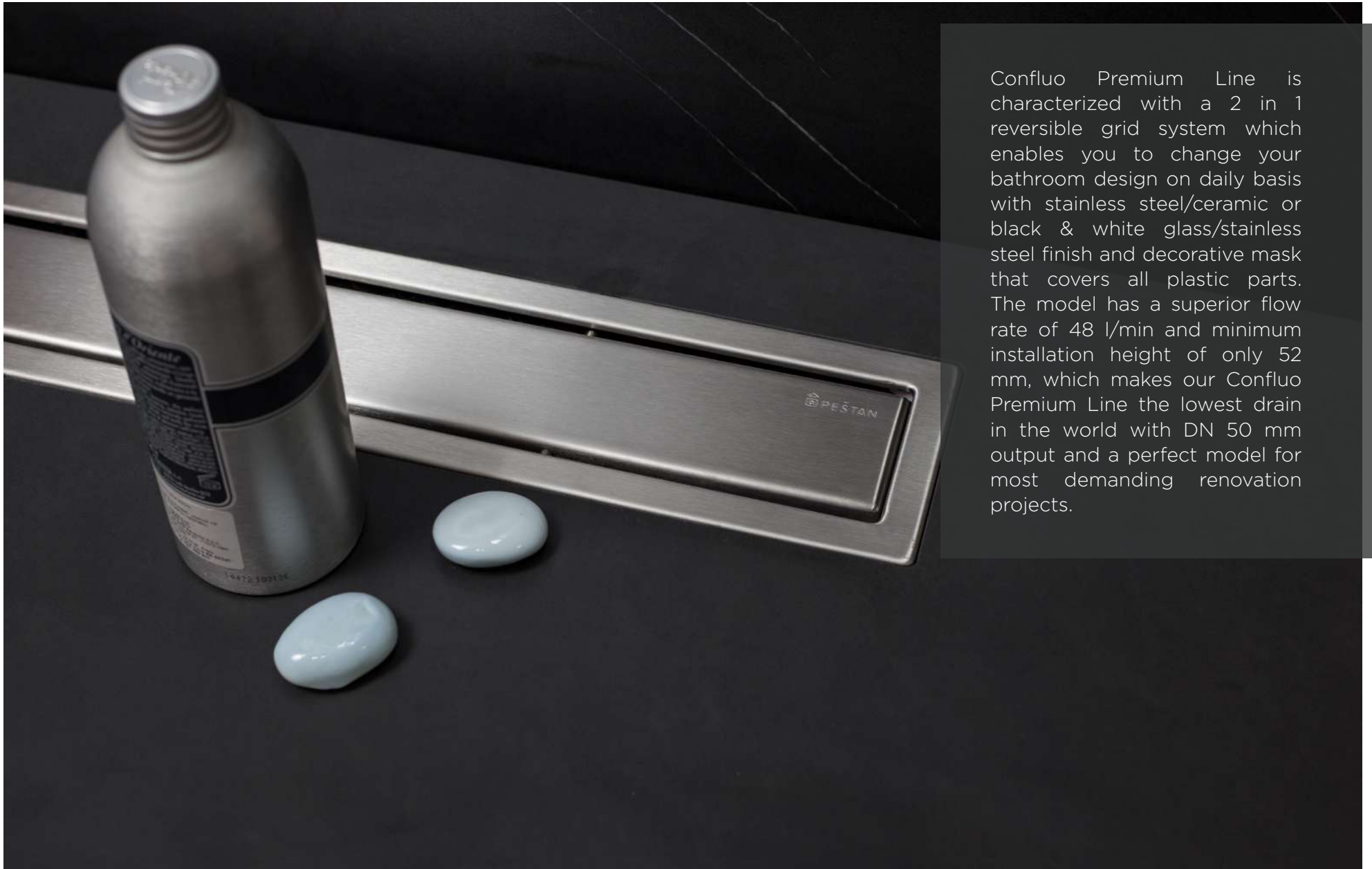

Confluo Premium Line is characterized with a 2 in 1 reversible grid system which enables you to change your bathroom design on daily basis with stainless steel/ceramic or black & white glass/stainless steel finish and decorative mask that covers all plastic parts. The model has a superior flow rate of 48 l/min and minimum installation height of only 52 mm, which makes our Confluo Premium Line the lowest drain in the world with DN 50 mm output and a perfect model for most demanding renovation projects.

Confluo **Premium** Line

Main advantages:

- Minimum installation height – 52 mm
- Maximum flow rate – 48 l/min
- Reversible grid – 2 in 1 system
- 360° rotatable self-cleaning S base
- Without visible plastic parts

Dimensions: 300, 450, 550, 650, 750, 850, 950 mm

Grid Design





Dry siphon for linear drains with O-Ring included for extra protection against bad smells and insects when water evaporate from S base.

* Not included in standard product. Needs to be ordered separately.



CONFLUO PREMIUM LINE

Premium 300 Premium 450 Premium 550 Premium 650 Premium 750 Premium 850 Premium 950

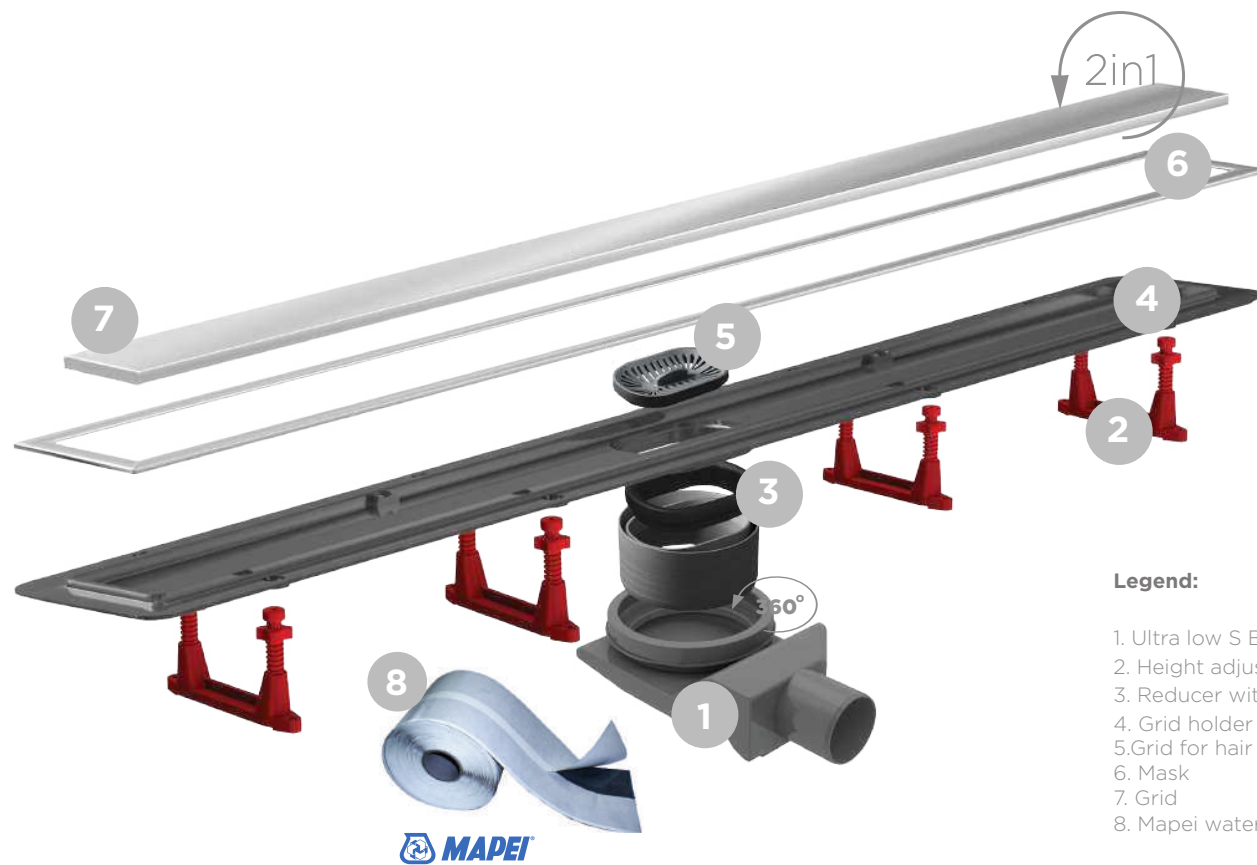

Legend:

1. Ultra low S Base
2. Height adjustment legs
3. Reducer with rubber ring
4. Grid holder
5. Grid for hair - flow rate 48 l/min
6. Mask
7. Grid
8. Mapei waterproofing butyl tape

52 mm

Min. installation height

48l/min

Maximum flow rate

2 in 1 system

2 in 1 system

SC

Self-cleaning base

K3

Load class of grid

50 output

Base diameter outlet

360° base rotation

Base rotation

25 mm

Water seal height

AISI 304

Material of grid



Stainless steel/Ceramic

Chopper/
Stainless steel

White Glass/
24k Gold Plated

| 2 in 1 System & Grid design options



Black Glass/
24k Gold Plated

24k Gold Plated

White Glass/
Stainless steel

Black Glass/
Stainless steel

Stainless steel/
Ceramic



For all your needs



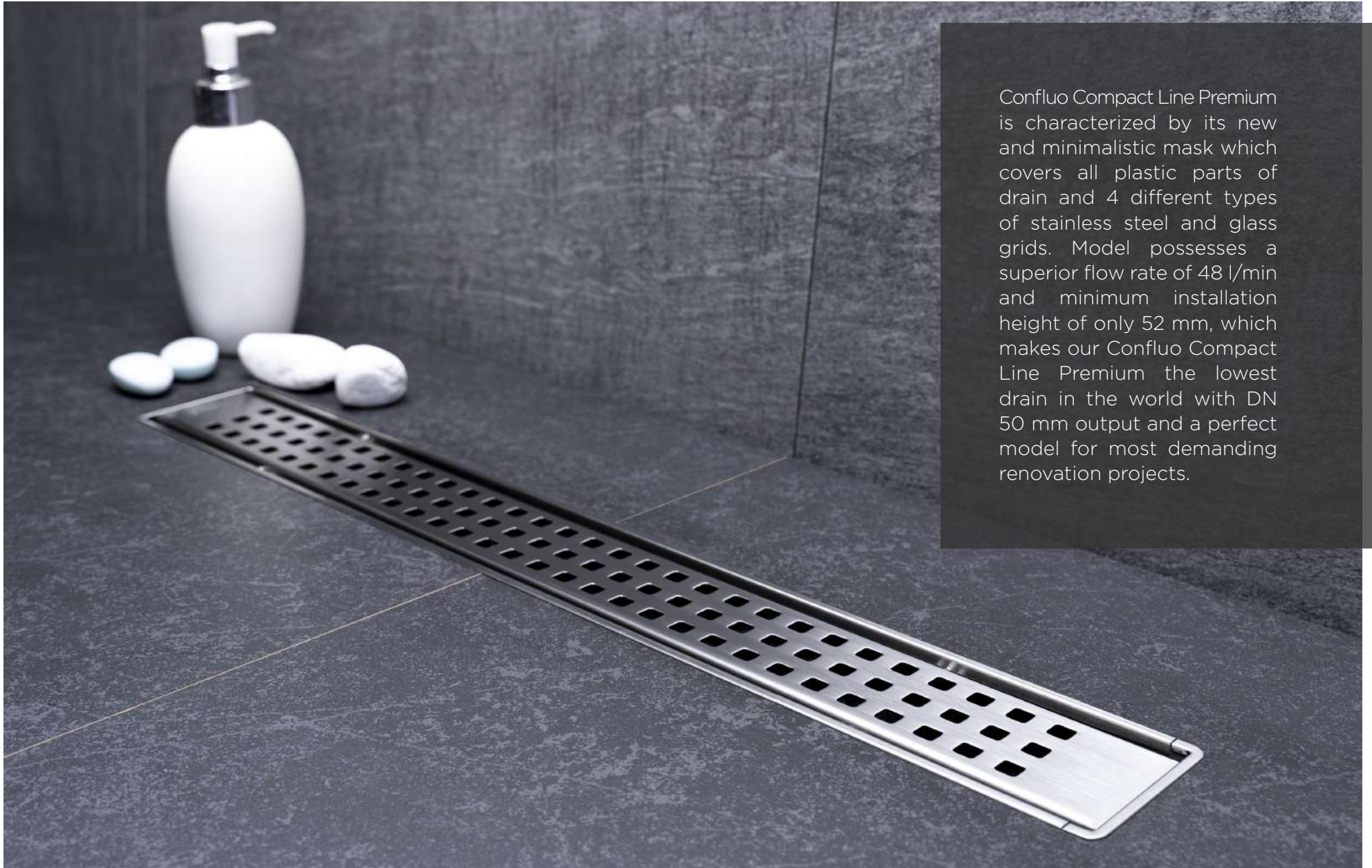

Confluo Compact Line Premium is characterized by its new and minimalistic mask which covers all plastic parts of drain and 4 different types of stainless steel and glass grids. Model possesses a superior flow rate of 48 l/min and minimum installation height of only 52 mm, which makes our Confluo Compact Line Premium the lowest drain in the world with DN 50 mm output and a perfect model for most demanding renovation projects.

Confluo **Compact** Line Premium

Main advantages:

- Minimum installation height – 52 mm
- Maximum flow rate – 48 l/min
- Combined siphon – wet + dry
- Reversible grid – 2 in 1 system
- 360° rotatable self-cleaning S base
- Without visible plastic parts

Dimensions: 300, 450, 550, 650, 750, 850, 950 mm

Grid Design





Dry siphon for linear drains with O-Ring included for extra protection against bad smells and insects when water evaporate from S base.

* Included in standard product.



CONFLUO **COMPACT NET LINE PREMIUM**

Compact Net
Line **300** Premium

Compact Net
Line **450** Premium

Compact Net
Line **550** Premium

Compact Net
Line **650** Premium

Compact Net
Line **750** Premium

Compact Net
Line **850** Premium

Compact Net
Line **950** Premium

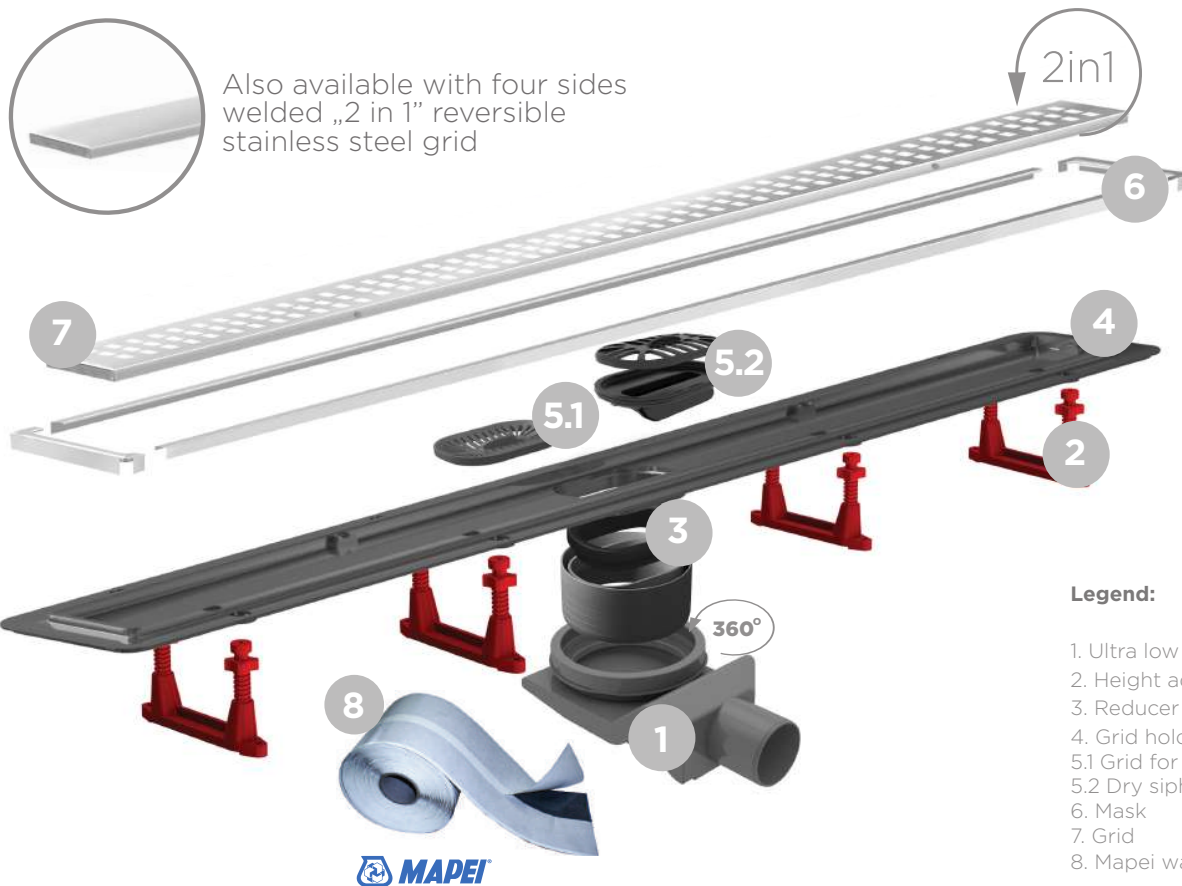

Legend:

1. Ultra low S Base
2. Height adjustment legs
3. Reducer with rubber ring
4. Grid holder
- 5.1 Grid for hair - flow rate 48 l/min
- 5.2 Dry siphon - flow rate 26 l/min
6. Mask
7. Grid
8. Mapei waterproofing butyl tape

52
mm

Min. installation height

48l/min

Maximum flow rate

2 in 1
system

2 in 1 system

SC

Self-cleaning base

K3

Load class of grid

50
output

Base diameter outlet

360° base
rotation

Base rotation

25
mm

Water seal height

AISI 304

Material of grid



One product



Two designs



Stainless steel/
Ceramic

Stainless steel

Black glass/
Stainless steel

White glass/
Stainless steel



Confluo Compact Line Premium



Confluo Compact Line Black Glass Premium



Confluo Compact Net Line Premium



Confluo Compact Line White Glass Premium

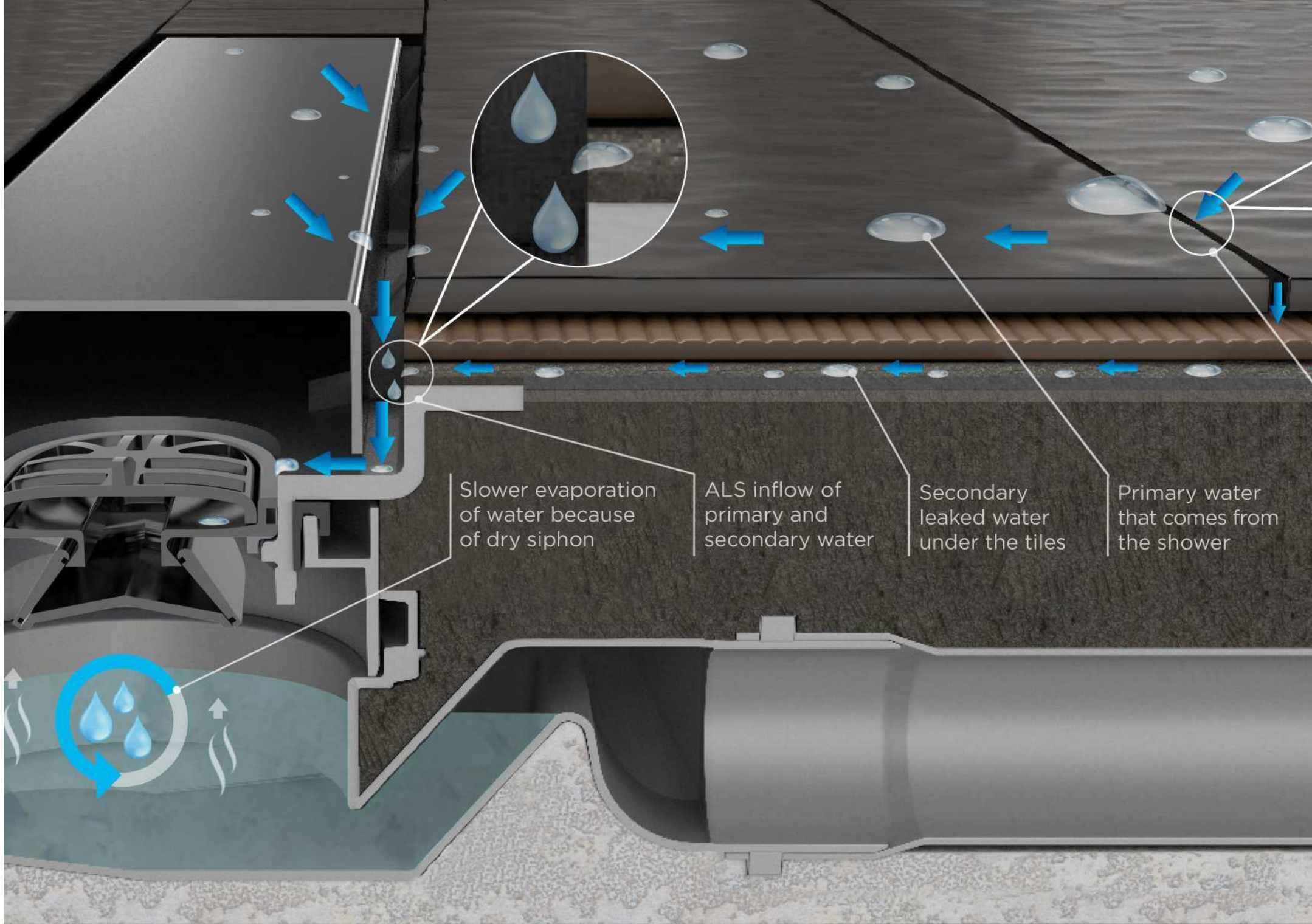

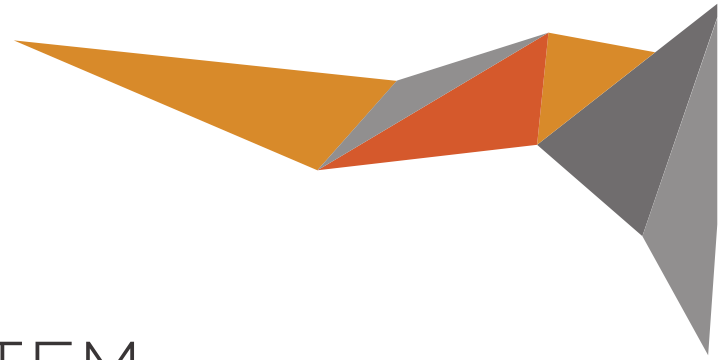

ALS ANTI-LEAKING SYSTEM

ALS – Anti-Leaking System represents combination of drain construction and proper installation, which allows all leaked and condensed water under the tiles to go back to the drain.

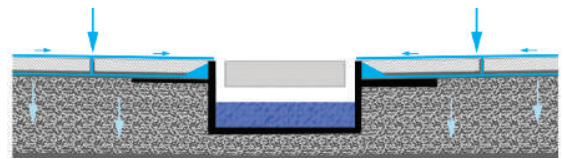
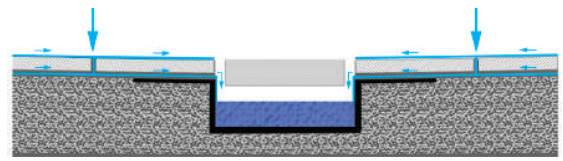
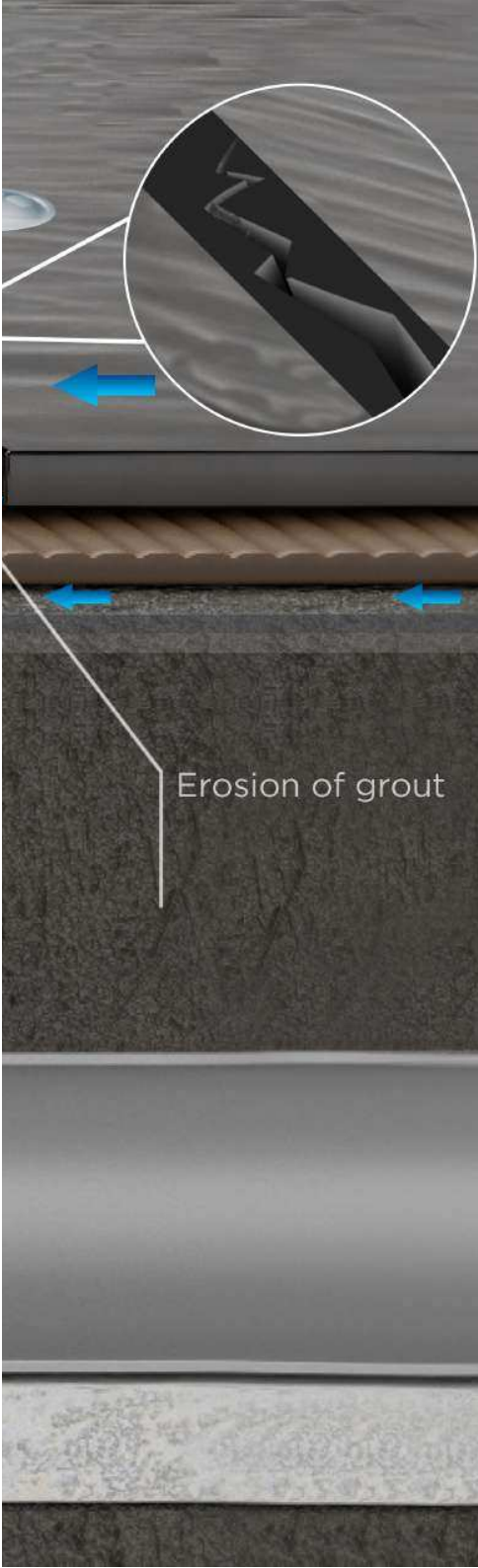

During the years, water in bathroom has tendency to build under the tiles as consequence of erosion of grout and moisture in the bathroom. Usually it takes 5-7 years until this problem happens and then a leakage shows up in a place where waterproofing was finished. We have solved this problem with our construction of grid holder, where you have no barrier for water under the tiles. Also, in order that this system works properly, it is very important to do correct slope screed and proper waterproofing as per our instruction manual.

Cross section of linear drain

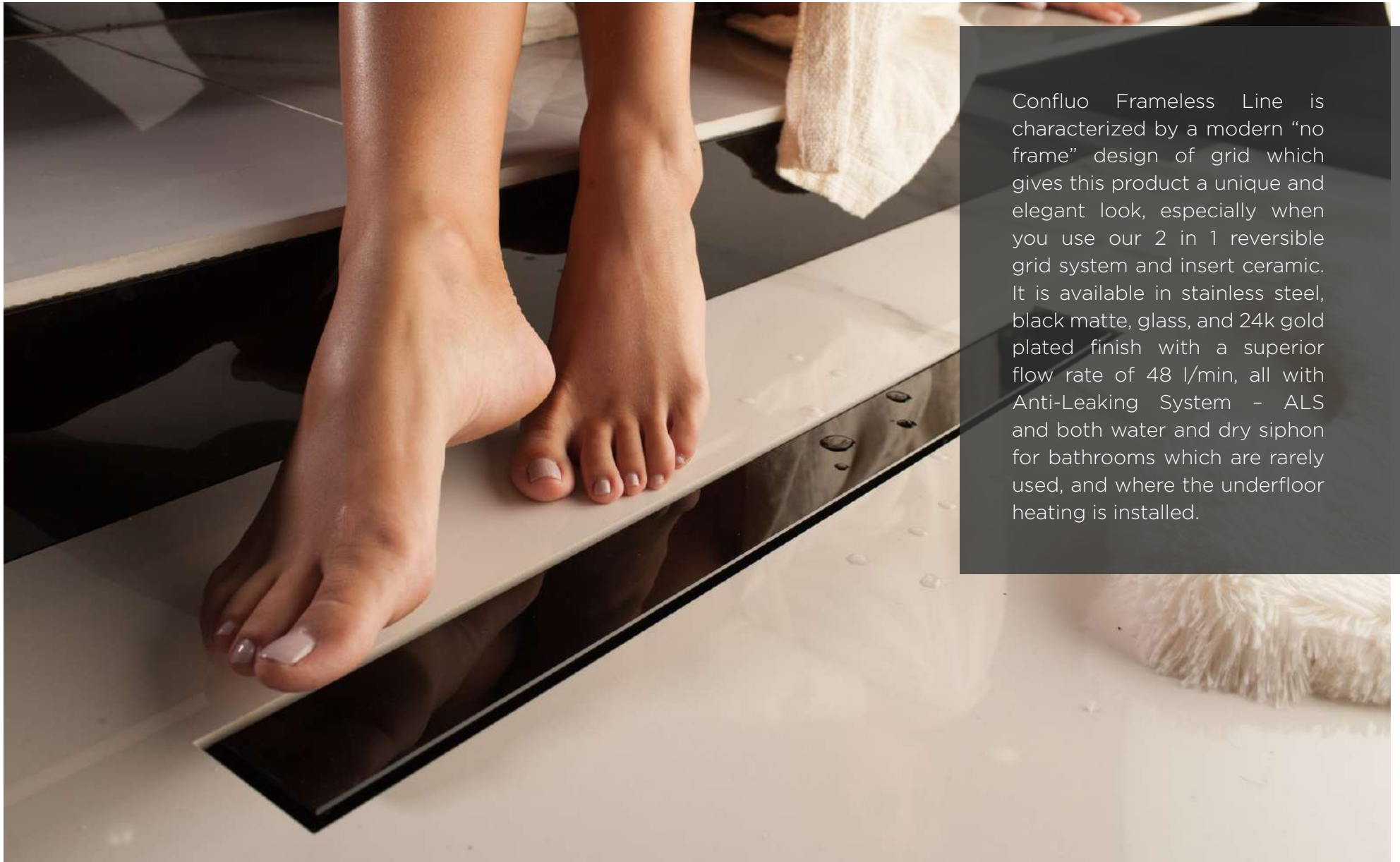

Confluo Frameless Line is characterized by a modern “no frame” design of grid which gives this product a unique and elegant look, especially when you use our 2 in 1 reversible grid system and insert ceramic. It is available in stainless steel, black matte, glass, and 24k gold plated finish with a superior flow rate of 48 l/min, all with Anti-Leaking System - ALS and both water and dry siphon for bathrooms which are rarely used, and where the underfloor heating is installed.

Confluo **Frameless** Line

Main advantages:

- Minimum installation height – 62 mm
- Maximum flow rate – 48 l/min
- ALS – Anti-Leaking System
- Reversible grid – 2 in 1 system
- 360° rotatable self-cleaning S base
- Combined siphon – wet + dry

Dimensions: 300, 450, 550, 650, 750, 850, 950 mm

Grid Design





PEŠTAN

Drysiphon for linear drains with O-Ring included for extra protection against bad smells and insects when water evaporate from S base.

* Included in standard product.



Confluo Frameless styrofoam with dual role — Protection during the installation of the drain and benchmark for perfect leveling of ceramic.



CONFLUO FRAMELESS LINE

FRAMELESS 300 FRAMELESS 450 FRAMELESS 550 FRAMELESS 650 FRAMELESS 750 FRAMELESS 850 FRAMELESS 950



Legend:

1. Ultra low S Base
2. Height adjustment legs
3. Reducer with rubber ring
4. Grid holder
- 5.1 Grid for hair — flow rate 48l/min
- 5.2 Dry siphon — flow rate 26l/min
6. Grid
7. Protective styrofoam
8. Mapei waterproofing butyl tape



Min. installation height

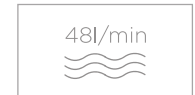

Maximum flow rate



Self-cleaning base



Load class of grid

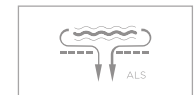

Anti-leaking system

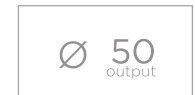

Base diameter outlet



Base rotation



Water seal height



Material of grid

| 2 in 1 System

Stainless steel/Ceramic

Black Glass/Stainless steel



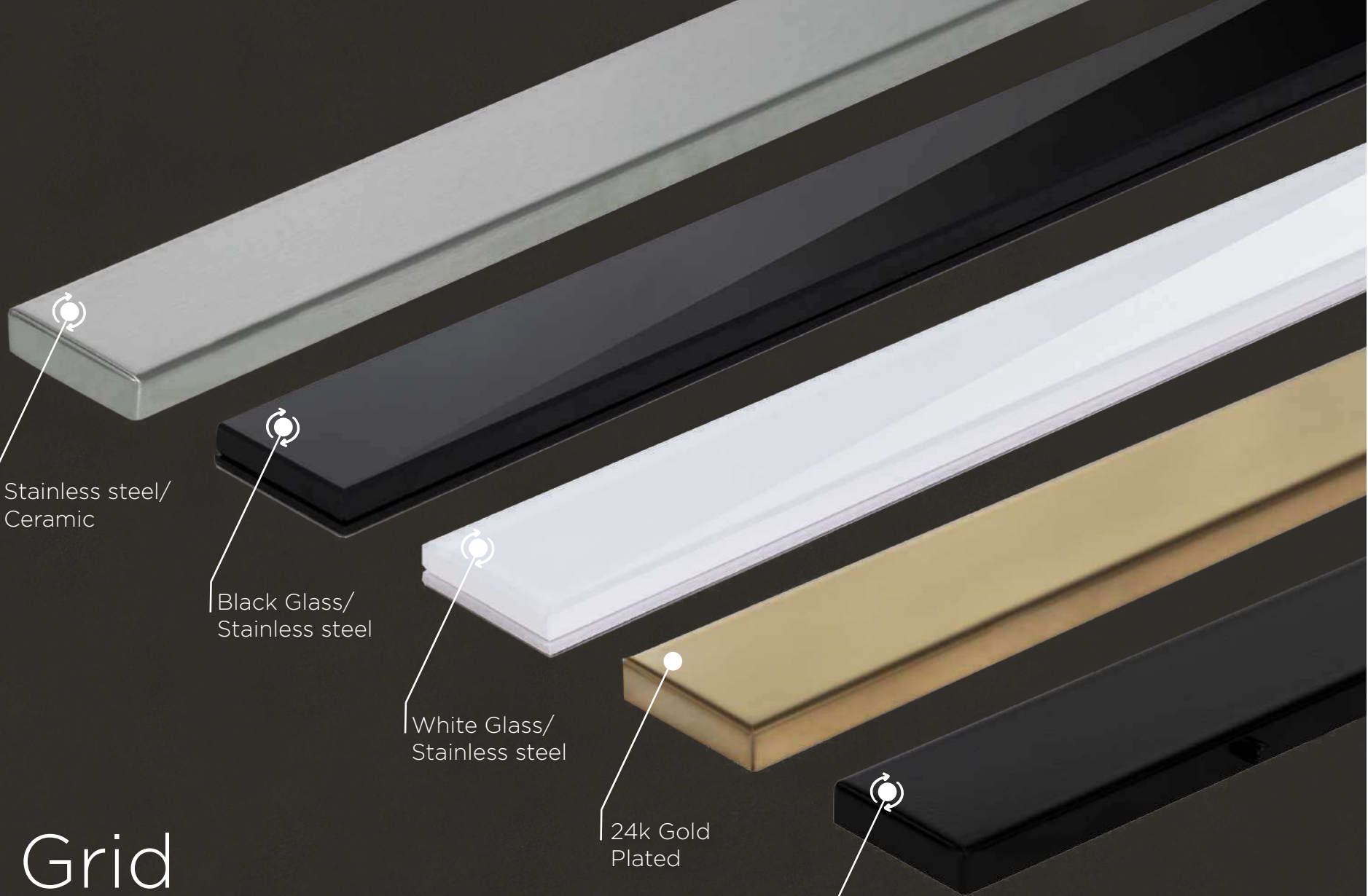

Stainless steel/
Ceramic

Black Glass/
Stainless steel

White Glass/
Stainless steel

24k Gold
Plated

Black matte/
Ceramic

Grid design options



Modern functionality

Confluo Frameless Line White Glass



Confluo Frameless Line Black Glass



Confluo Frameless Line Black Matte



Confluo Frameless Line Gold

| Minimalistic design





The Confluo FIX line of bathroom drain with a fixed base is characterized by ease of installation and maintenance. The drain size of 50 mm (DN50) allows the siphon to drain large amounts of water. The siphon is fixed to the sink body, which makes installation very simple. The drain is with a horizontal connection and size DN50mm, so no adapters are needed for connecting to the pipeline. By simply removing the siphon cover, cleaning and maintenance is very simple and affordable. High water flow ensures efficient drainage without water retention in the shower area. The low installation height makes the downspout flexible in terms of installation in renovated or new buildings. The 2in1 system allows the drain to fit perfectly into the design of modern bathrooms. Although the drain body and siphon are made of the highest quality ABS plastic, there are no visible plastic parts after installation. Metal grills and masks are made of high-quality stainless steel (SS304) available in Chrome, Matt Black and Copper finishes. The grids withstand the K3 load class

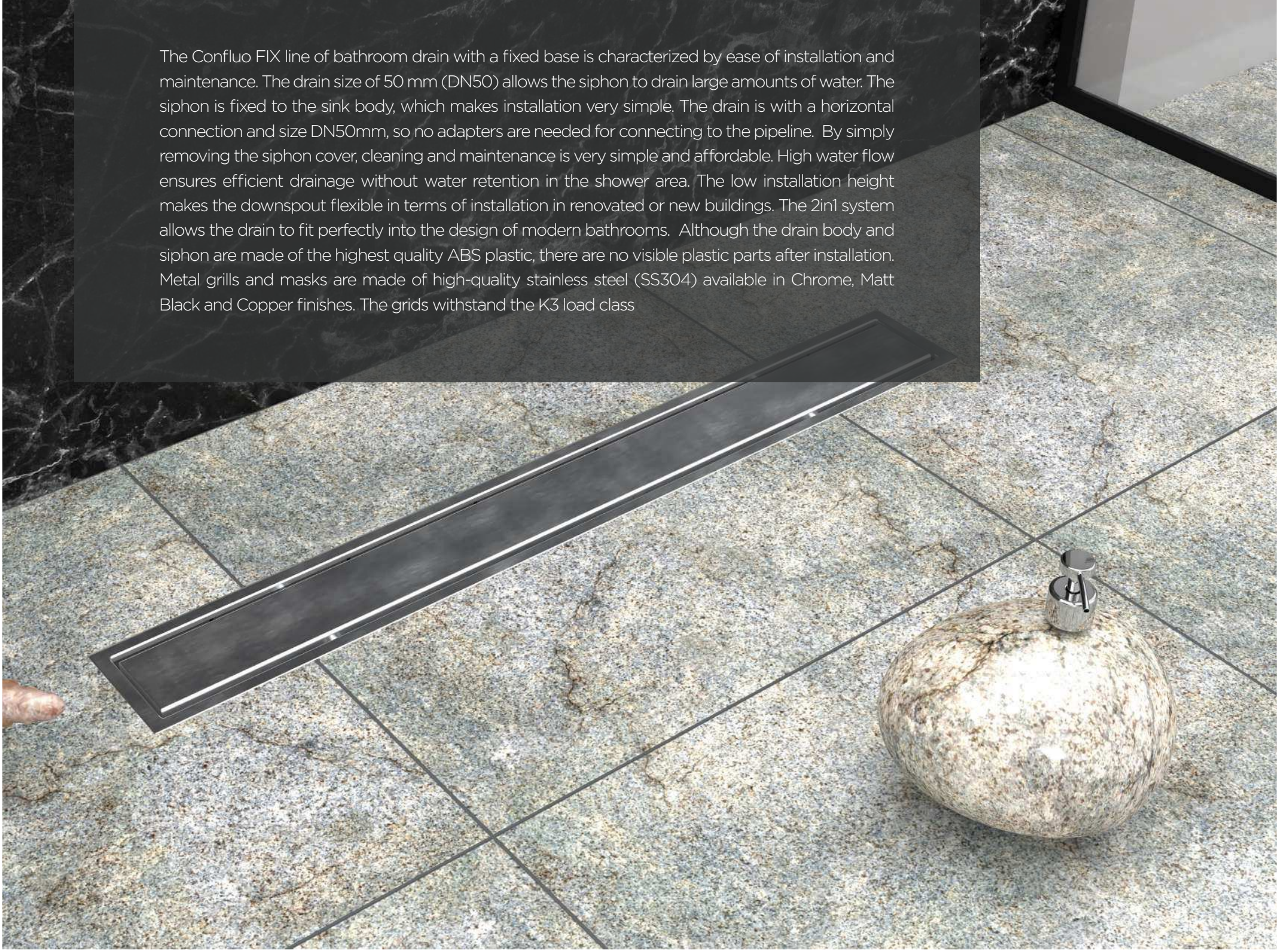



Confluo **Fix** Line

Main advantages:

- Minimum installation height – 64 mm
- Maximum flow rate – 48 l/min
- Reversible grid – 2 in 1 system
- Fixed siphon for drain body
- Without visible plastic parts

Dimensions: 450, 550, 650, 750 mm

Grid design:

Stainless Steel/
Ceramics

Black glass /
Stainless Steel

White Glass /
Stainless Steel



Silicone membrane, prevents the appearance of unpleasant smell thanks to the unique silicone solution membrane, which prevents the appearance of the negative pressure and disappearance of water from siphon.

Confluo **Fix** Line

Fix **450**

Fix **550**

Fix **650**

Fix **750**

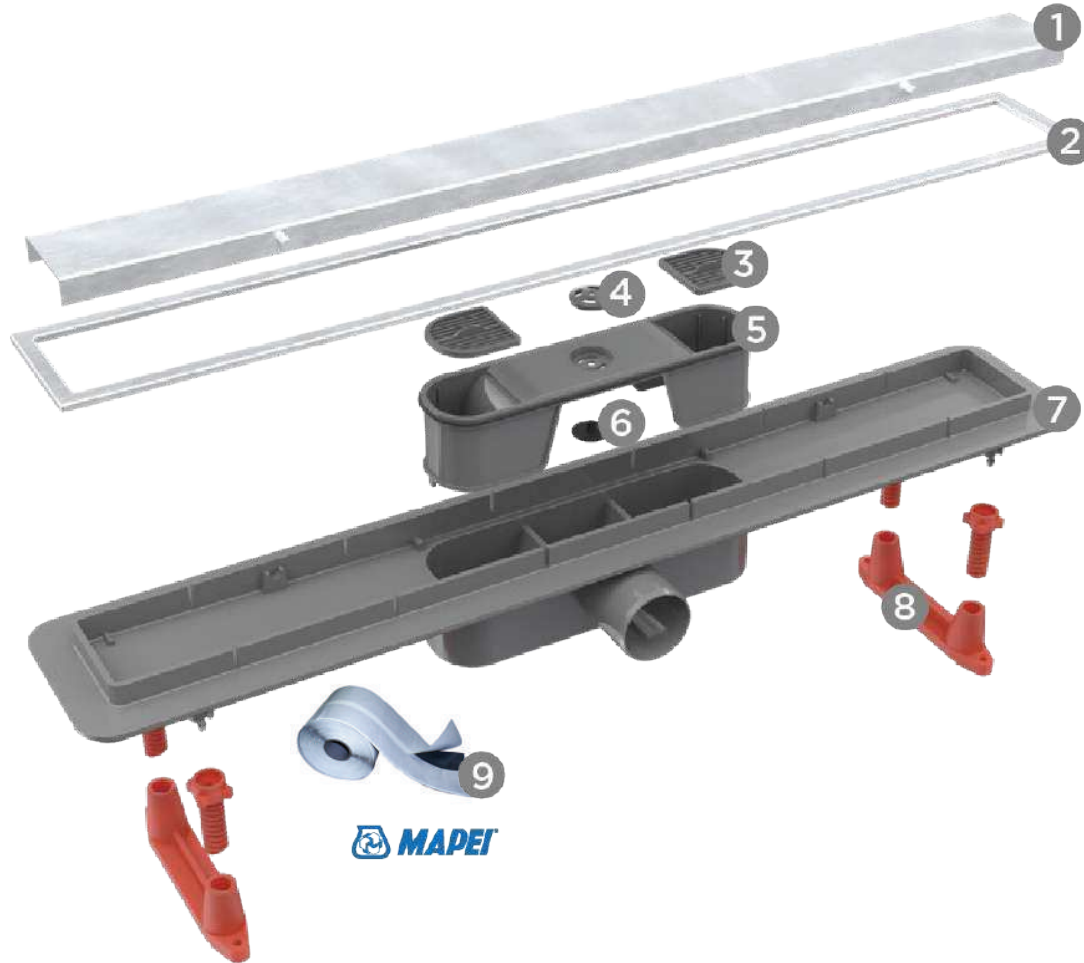

Legend:

1. Drain Grid
2. Grid mask
3. Grid for hair
4. Holder with membrane
5. Siphon with membrane
6. Silicone membrane
7. Grid holder with fixed base
8. Height adjustment legs
9. Mapei waterproof butyl tape



Fixed base

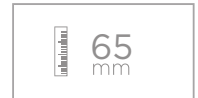

Min. installation height



Water seal height



Anti-leaking system



Anti vacuum system

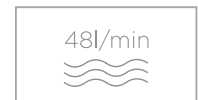

Maximum flow rate



Material of grid



2 in 1 system



Handicapped accessible



Load class of grid



Base diameter outlet



Easy cleaning system



Confluo Slim Line is characterized by minimalist "Slim" design of stainless steel grid, which gives your bathroom a totally different and modern look. The model has the possibility of grid leveling from 5-20 mm, which allows various options when you choose your bathroom surface. Anti-Leaking System - ALS is also one of the main advantages of "Slim", which is designed in the way that all the condensed and leaked water under the tiles can go back to the drain without any obstacles.

Confluo **Slim** Line

Main advantages:

- Minimum installation height — 72 mm
- ALS — Anti-Leaking System
- Unique and minimalist design of grid
- 360° rotatable self-cleaning S base
- Height adjustable grid — 5—20 mm

Dimensions: 300, 450, 550, 650, 750, 850, 950 mm

Grid Design

STAINLESS STEEL



CONFLUO SLIM LINE

Slim 300 Slim 450 Slim 550 Slim 650 Slim 750 Slim 850 Slim 950

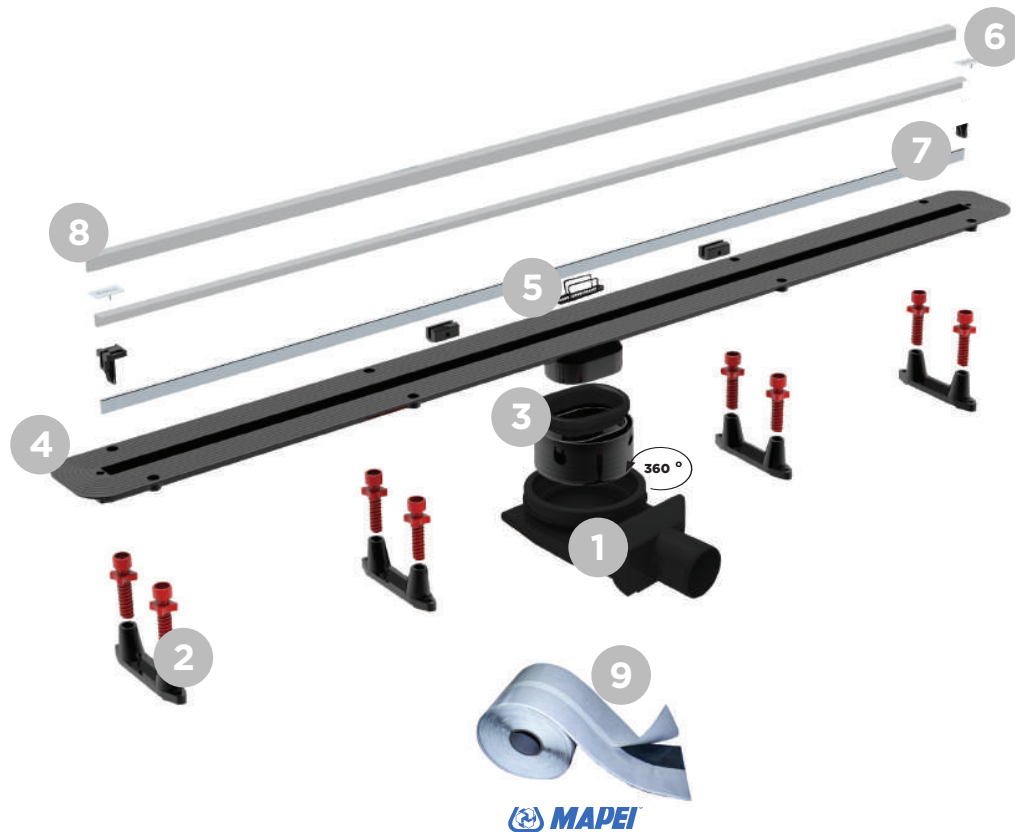

Legend:

1. Ultra low S Base
2. Height adjustment legs
3. Reducer with rubber ring
4. Holder of grid
5. Grid for hair
6. Decorative Plate
7. Grid
8. Aluminum profile for ceramic
9. Mapei waterproofing butyl tape



Min. installation height

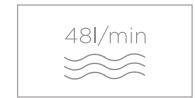

Maximum flow rate



Self-cleaning base



Water seal height



Handicapped accessible



Anti-leaking system



Base diameter outlet



Fine ceramic adjustment



Base rotation



Confluo Wall Drain is an innovative concept in the shower drains industry. Possibility of positioning the drain into the wall instead of the floor gives your bathroom a huge number of possibilities, both technically and design-wise. The model has an Anti-Leaking System - ALS, superior flow rate of 48 l/min, the minimum installation height of 56 mm, and installation depth of 80 mm, which makes this model perfect for bathrooms with concealed cisterns and renovation projects with limited space.

Confluo **Wall** drain

Main advantages:

- Minimum installation height – 56 mm
- Maximum flow rate – 48 l/min
- ALS – Anti-Leaking System
- 360° rotatable self-cleaning S base
- Perfect model for renovations
and bathrooms with concealed cistern

Dimensions: 300 mm

Grid Design

Stainless steel

24k GOLD PLATED

CONFLUO WALL DRAIN

WALL 300

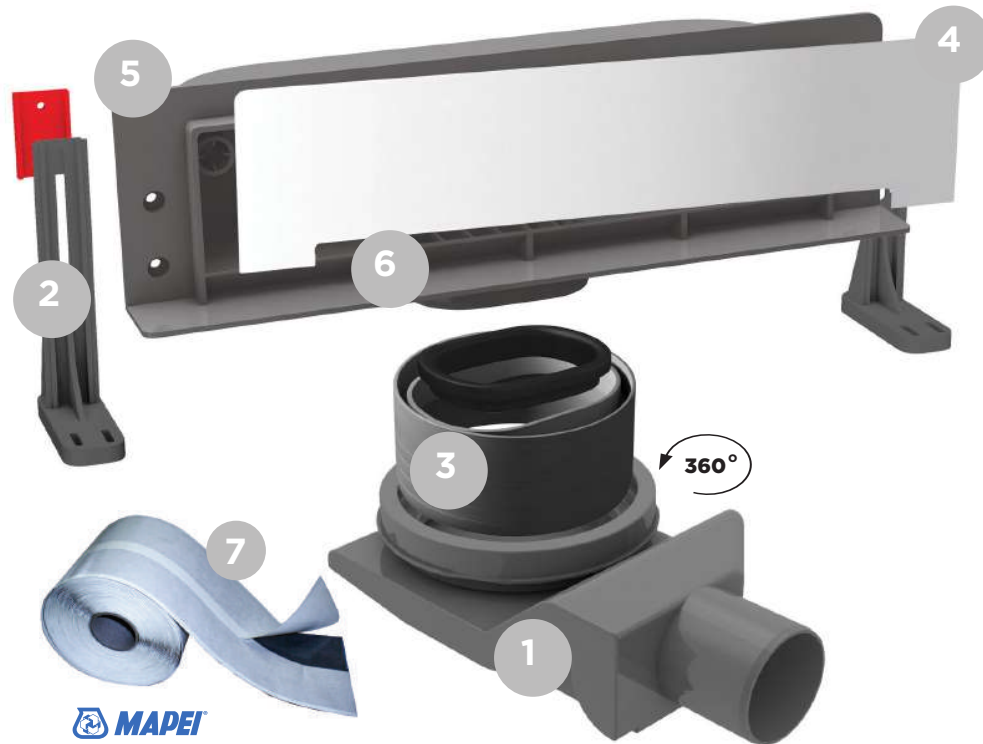

Min. installation height

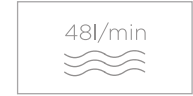

Maximum flow rate



Self-cleaning base



Water seal height



Handicapped accessible

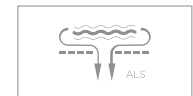

Anti-leaking system



Base diameter outlet



Base rotation

Legend:

1. Ultra low S Base
2. Height adjustment legs
3. Reducer with rubber ring
4. Grid
5. Grid holder
6. ALS chambers
7. Mapei waterproofing butyl tape



ALS ANTI-LEAKING SYSTEM

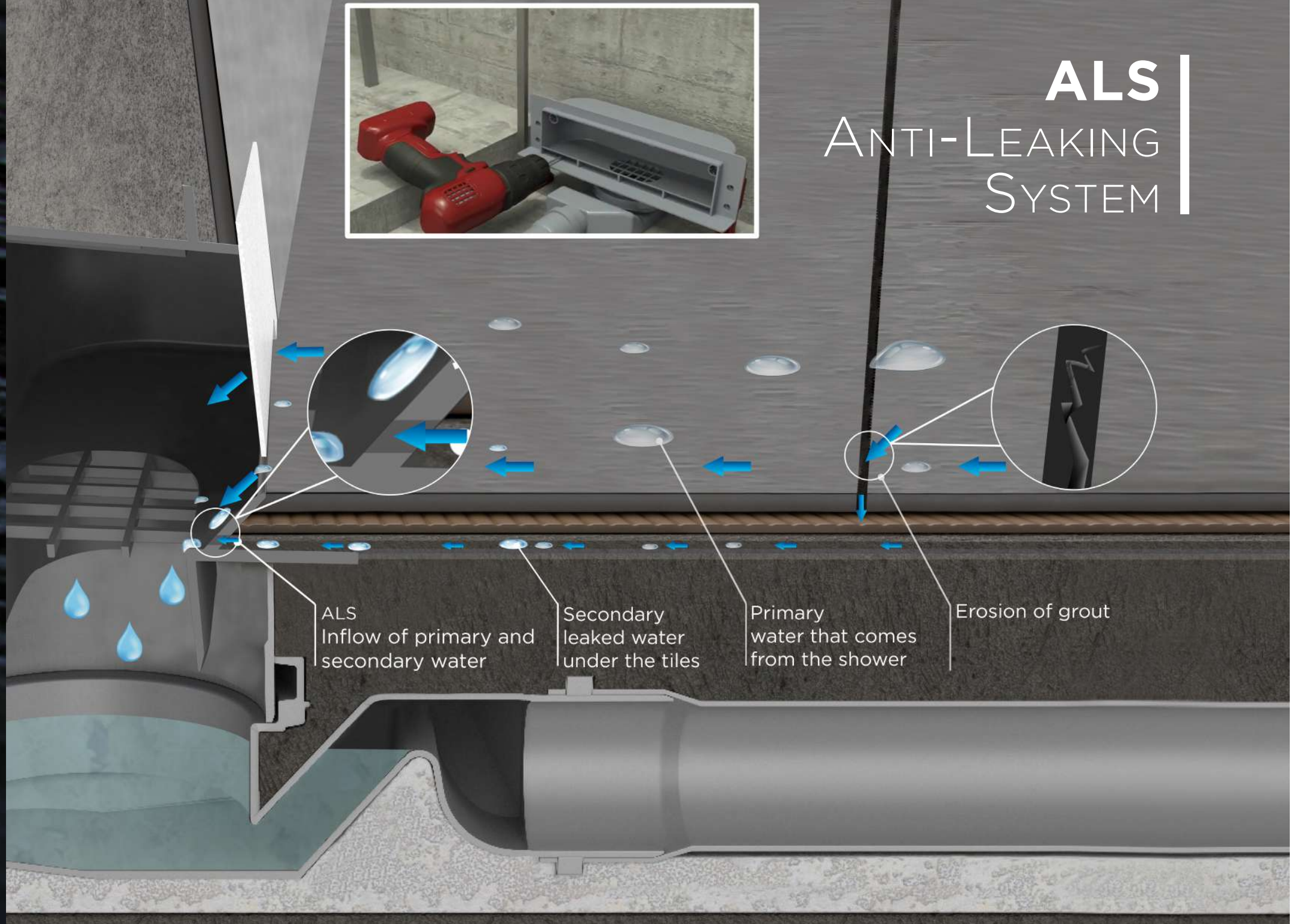

ALS
Inflow of primary and
secondary water

Secondary
leaked water
under the tiles

Primary
water that comes
from the shower

Erosion of grout

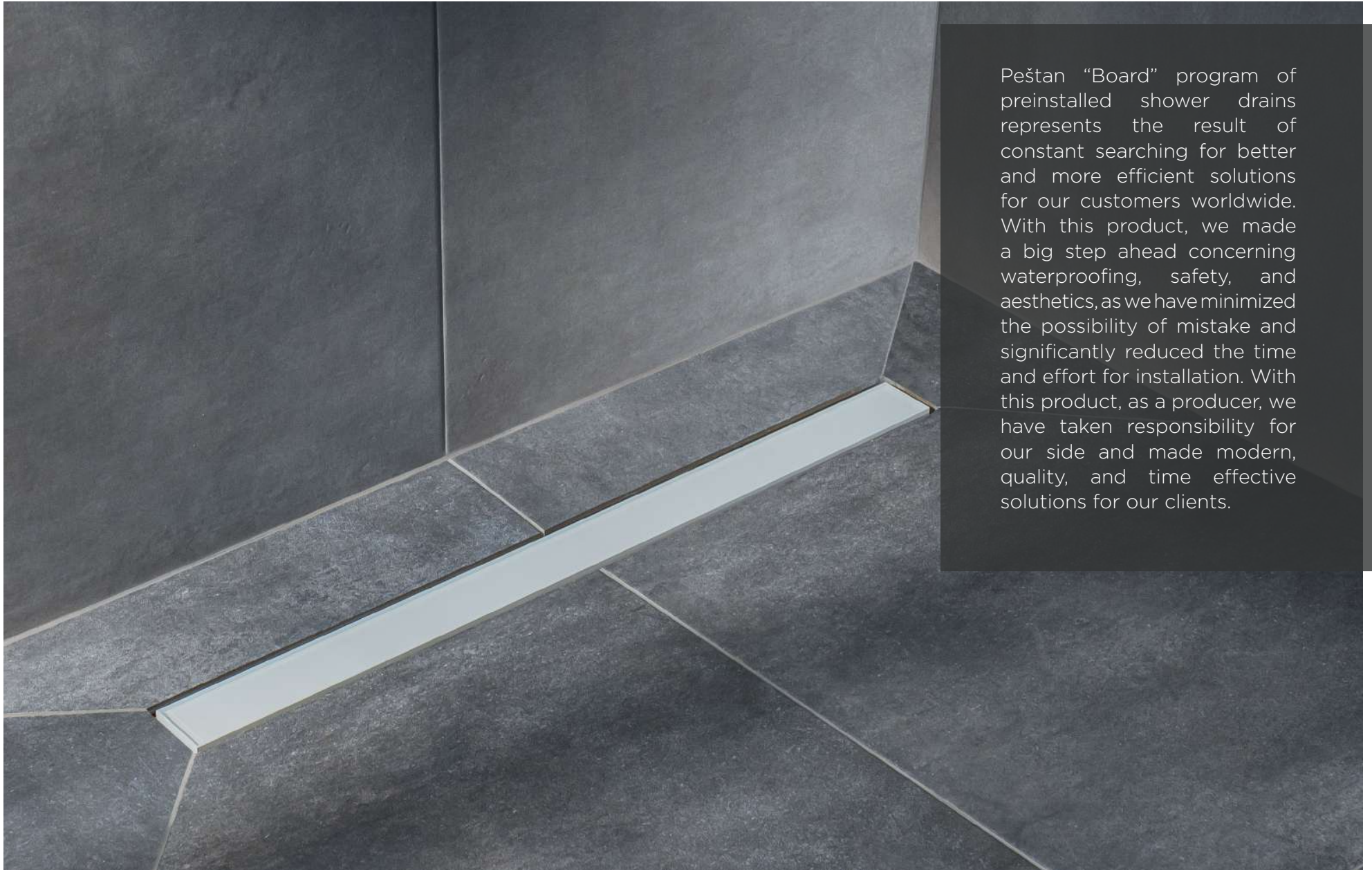

Peštan “Board” program of preinstalled shower drains represents the result of constant searching for better and more efficient solutions for our customers worldwide. With this product, we made a big step ahead concerning waterproofing, safety, and aesthetics, as we have minimized the possibility of mistake and significantly reduced the time and effort for installation. With this product, as a producer, we have taken responsibility for our side and made modern, quality, and time effective solutions for our clients.

Confluo **Board**

Main advantages:

- Peripor Board — 45 kg/m³
- MAPEI waterproofing
- Time and cost effective
- High Flow Rate — 48 l/min
- ALS — Anti-Leaking System
- Combined siphon — wet + dry

Board dimensions:

- UNI 900
- UNI 1200
- 900X900X80/95 mm
- 900X900X38/52 mm
- 1200X1200X80/95 mm
- 1200X1200X35/54 mm

Grid Design



We produce our Confluo Board Frameless Line in 2 dimensions (900 x 900 mm & 1200 x 1200 mm) and a few board thicknesses, depending on whether you are renovating or making a new building. The product comes with 5 different 2 in 1 grid designs (Chrome/Ceramic, Black Glass/Chrome, White Glass/Chrome, Matte Black/Ceramic, and Gold), 360° rotatable S base with drainage capacity of 48 l/min and ALS - Anti-Leaking System. Our boards are made of high-quality peripor with a density of 45 kg/m³ with preinstalled slopes and it is coated with MAPELASTIC TURBO and MAPEBAND waterproofing.

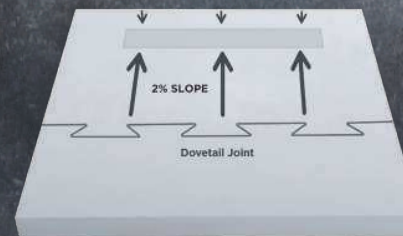

A great benefit of the Confluo "Board" preinstall shower drains is that installation time and price are significantly reduced as a board has integrated slopes and applied MAPEI waterproofing.

CONFLUO BOARD FRAMELESS LINE

BOARD FRAMELESS UNI 900 BOARD FRAMELESS UNI 1200 BOARD FRAMELESS 900X900X 80/95 BOARD FRAMELESS 900X900X 38/52 BOARD FRAMELESS 1200X1200 80/95 BOARD FRAMELESS 900X900X 35/54

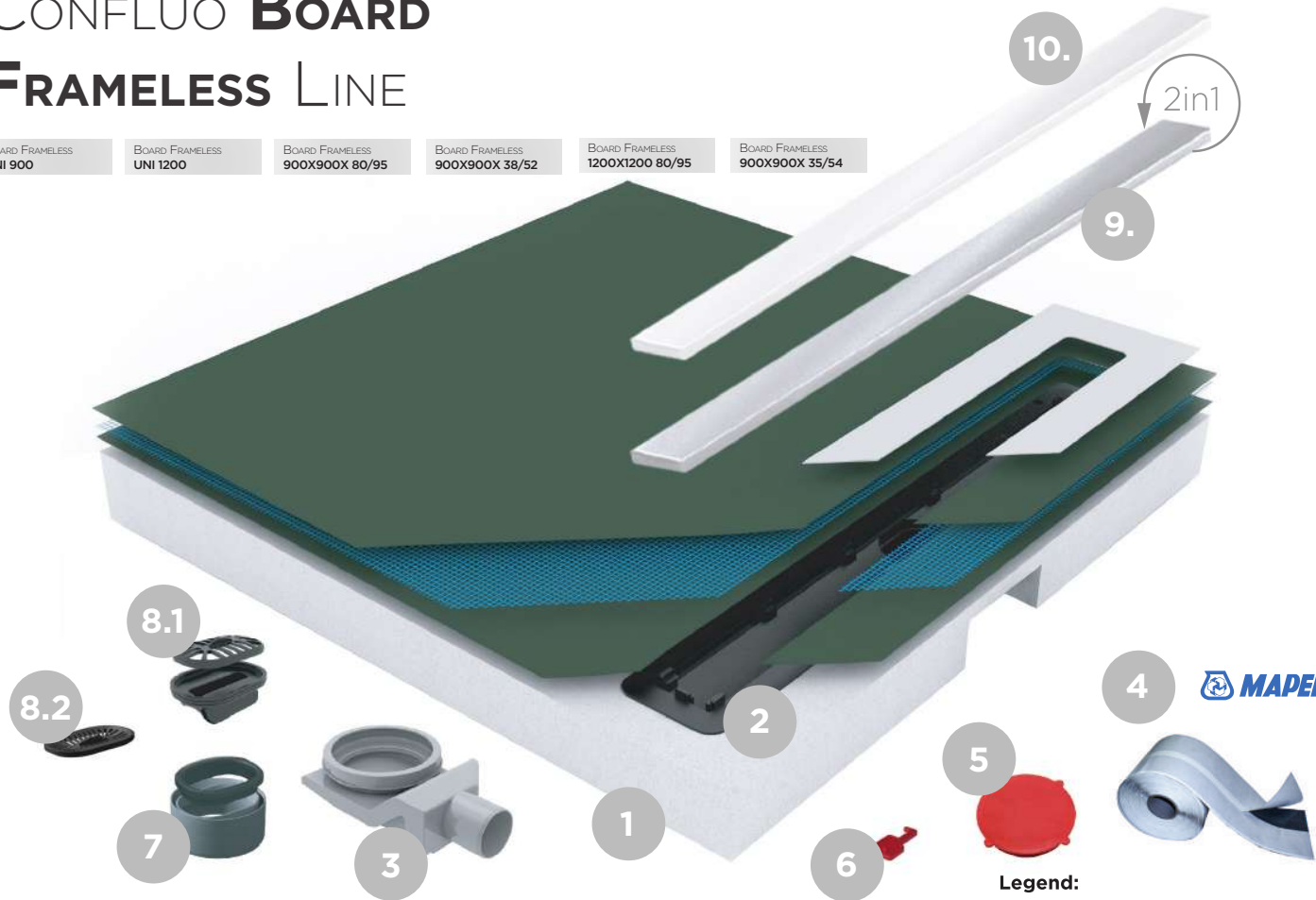

* Board and grid are sold separately

- In both UNI 900 and UNI 1200 is integrated Frameless Line 550 mm
- In 1200x1200 mm Confluo Board is integrated Frameless Line 850 mm
- In 900x900 mm Confluo Board is integrated Frameless Line 750 mm

Legend:

1. Peripor board with integrated waterproofing
2. Grid holder
3. Ultra low S base
4. MAPEBAND tape
5. Protective cap
6. Maintenance key
7. Reducer with rubber ring
- 8.1 Dry siphon
- 8.2 Grid for hair
9. Grid
10. Protective styrofoam

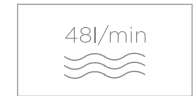

Maximum flow rate



2 in 1 system



Self-cleaning base



Water seal height

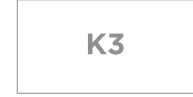

Load class of grid



Handicapped accessible



Anti-leaking system



Base diameter outlet



Base rotation



Material of grid

Confluo Board benefits:

1. **Peripor Board** - Peripor is expandable polystyrene (EPS) that is particularly suitable for applications exposed to compressive load. The most important properties of Peripor are:

- Excellent thermal insulation capacity
- High density — 45 kg/m³
- Outstanding impact absorption
- Low weight
- Imperviousness to moisture

2. **MAPEI waterproofing** - On Confluo Board is factory applied one of the most quality waterproofings, MAPELASTIC Turbo two-components rapid-drying elastic cementitious mortar and MAPEI waterproofing butyl tape which guarantees 100% water tightness of our system.

3. **Dovetail Joint** - This method of joining the plates provides the strength of a joint that is resistant to all possible stresses. Also, it prevents entering concrete between the plates.

4. **Time and cost-effective** - A great benefit of the Confluo “Board” preinstall shower drains is that installation time and price is significantly reduced as a board have integrated slopes and applied MAPEI waterproofing.

5. **High Flow Rate** - System provides a flow rate of 48l/min, which is in accordance with the highest standards.

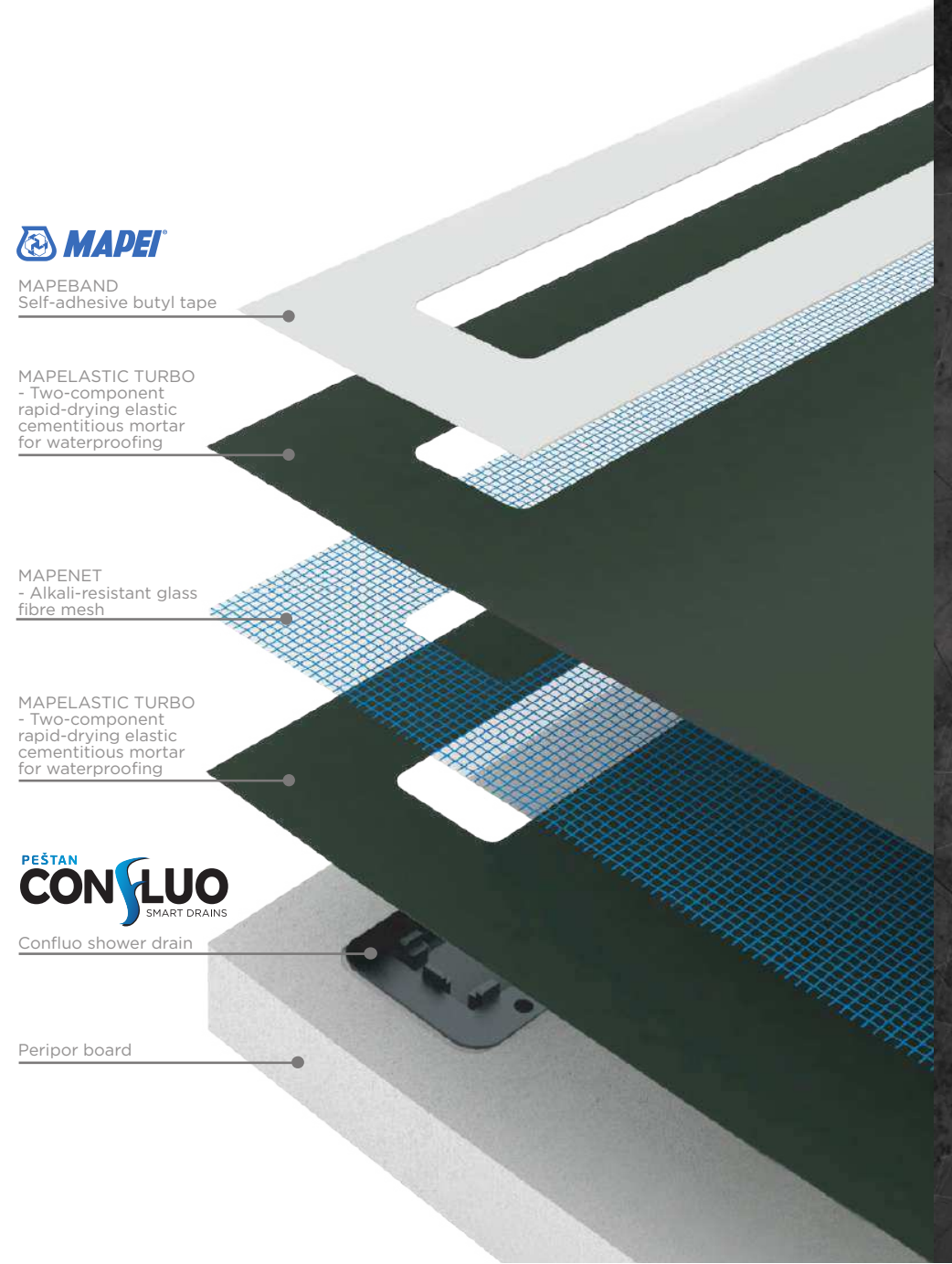

Confluo **UNI** Board

Board dimensions:

- 900 x 900 mm
- 1200 x 1200 mm

Grid dimensions:

- 550 mm

1st layer thickness:

- 38 - 52 mm Board UNI 900
- 35 - 54 mm Board UNI 1200

1st + 2nd layer total thickness:

- 80 - 95 mm

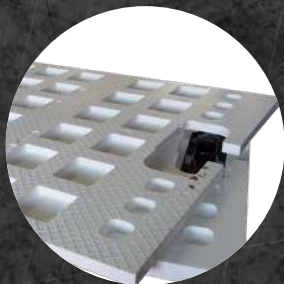
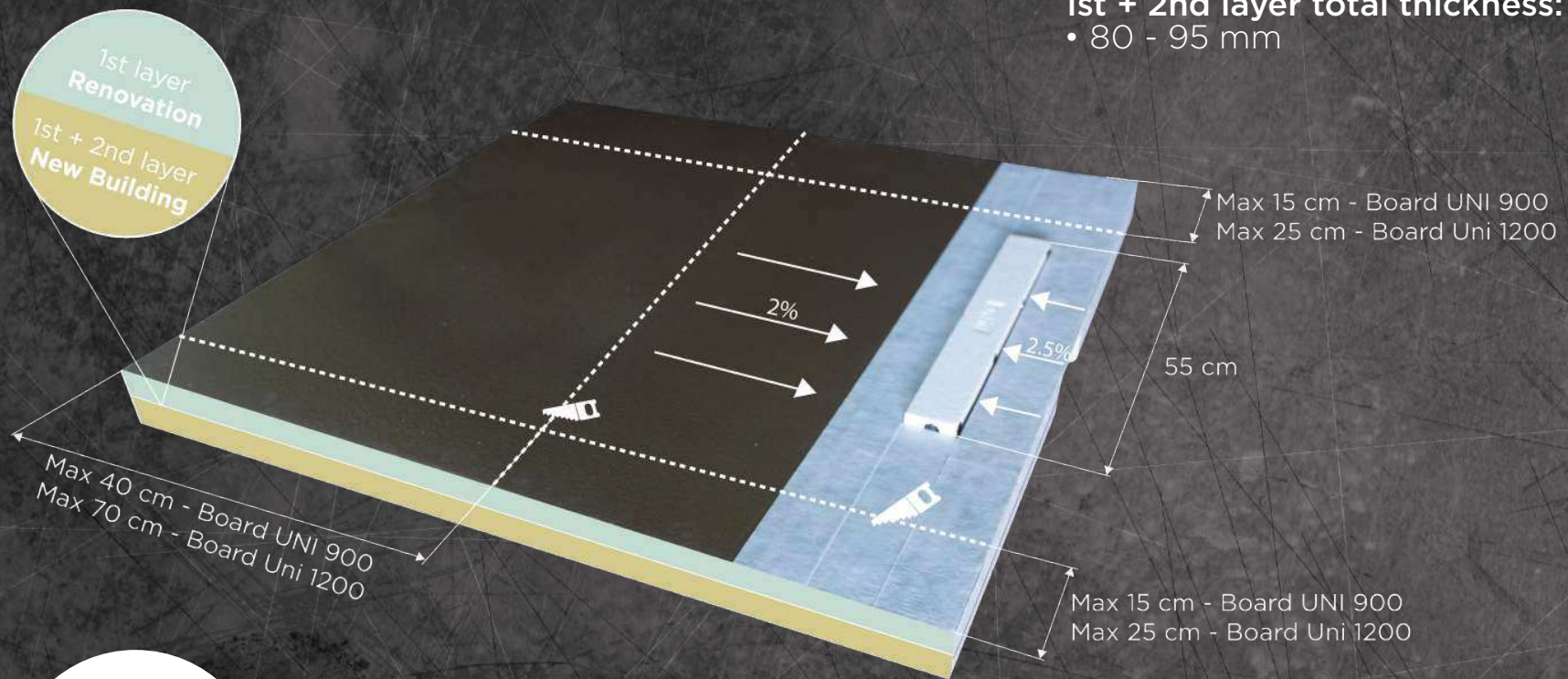

The product box contains already cut Confluo board on 2 thicknesses. If you use only the top layer it is a perfect model for renovation with under 40mm board height in the lowest point. If you use both layers it transforms Confluo Board Uni in an ideal solution for bathrooms with only concrete slab and replaces screed in shower area 100%.

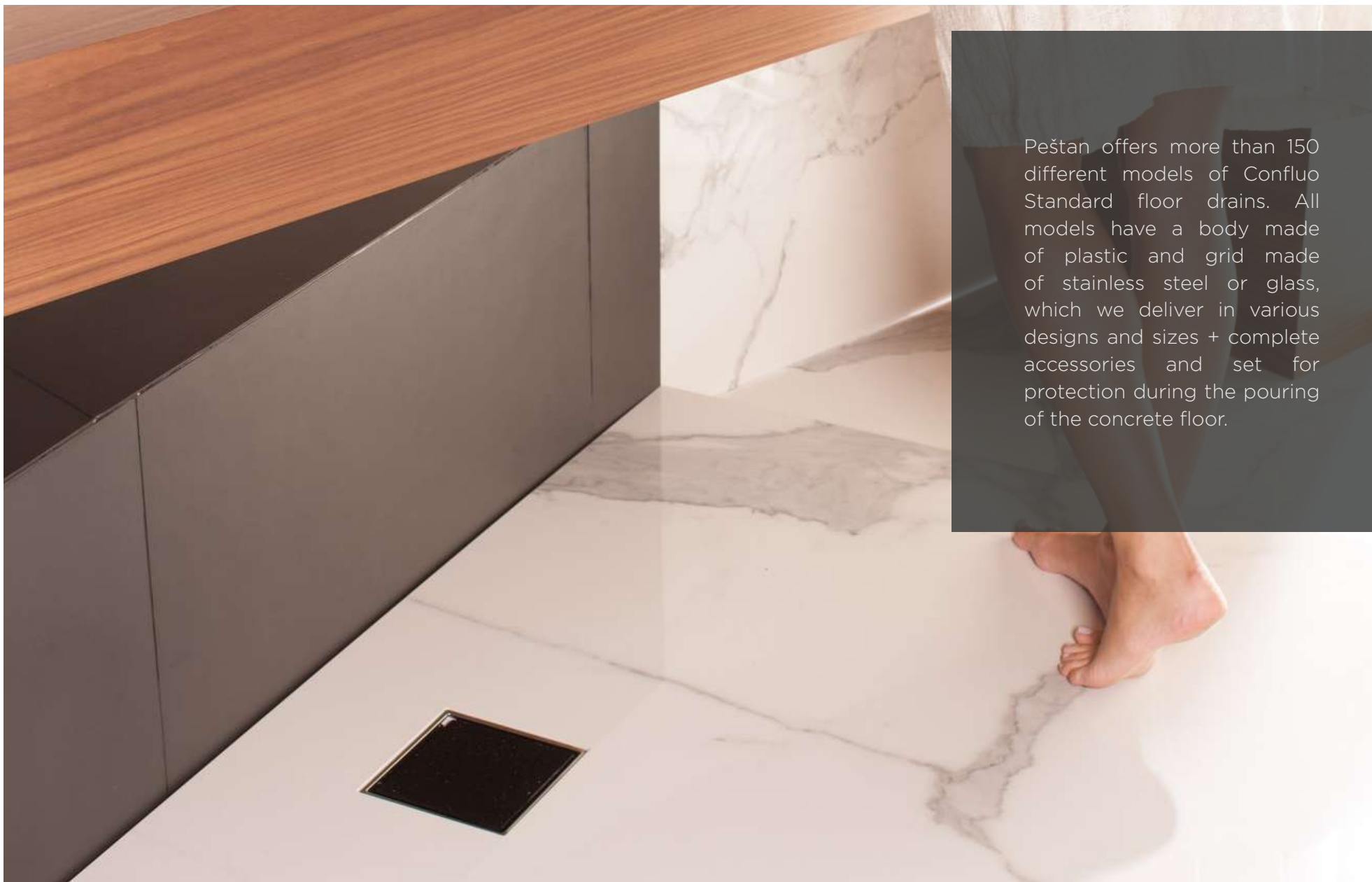

Peštan offers more than 150 different models of Confluo Standard floor drains. All models have a body made of plastic and grid made of stainless steel or glass, which we deliver in various designs and sizes + complete accessories and set for protection during the pouring of the concrete floor.

Confluo **Standard**

Main advantages:

- Minimum installation height — 56—78 mm
- Maximum flow rate — 48 l/min
- Unlimited leveling of ceramic
- Modularity — 7 different output options,
4 different siphons, 11 grid options
- Rotable — 360° base rotation + 15° angle rotation

Grid finish



Types of Confluo **Standard** Grids



SQUARE 15x15



TIDE 15x15 AND 10x10

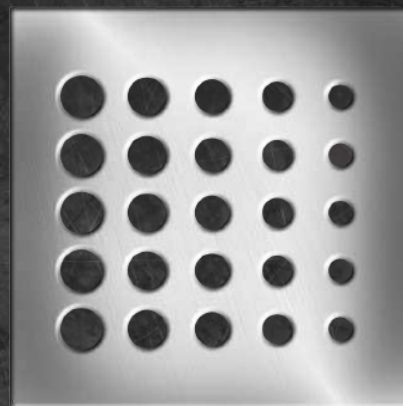

DROPS 15x15



PLATE 2 IN 1
15x15 AND 10x10



ANGLE 20x20



BLACK GLASS
15x15 AND 10x10



WHITE GLASS
15x15 AND 10x10



CERAMIC
15x15 AND 10x10

Types of bases for Confluo **Standard** drains



BASE WITH
1 HORIZONTAL OUTLET

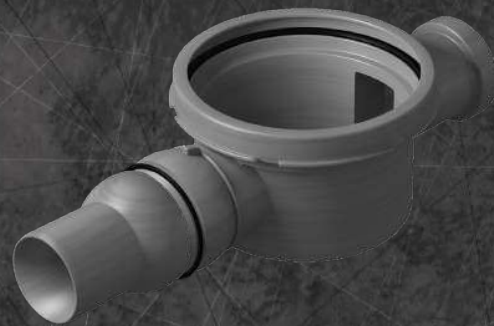

BASE WITH 1 HORIZONTAL
OUTLET/1 INLET



BASE WITH 1 HORIZONTAL
OUTLET/3 INLETS



VERTICAL BASE



VERTICAL BASE
FOR DRY SIPHON MODELS

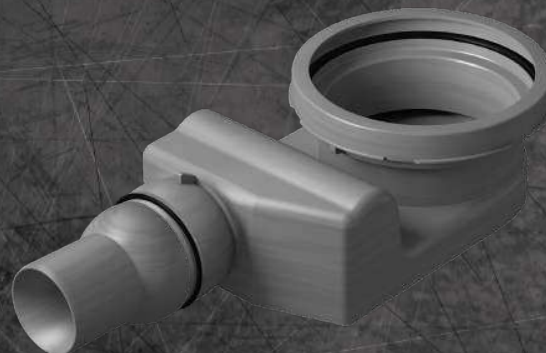

S BASE WITH 28 MM OF WATER
SEAL AND ADJUSTABLE OUTPUT

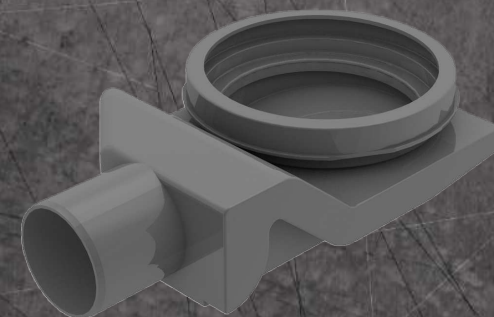

ULTRA LOW S BASE WITH
25 MM OF WATER SEAL



Confluo **Standard** drains with metal grid

Models with 15x15 grid

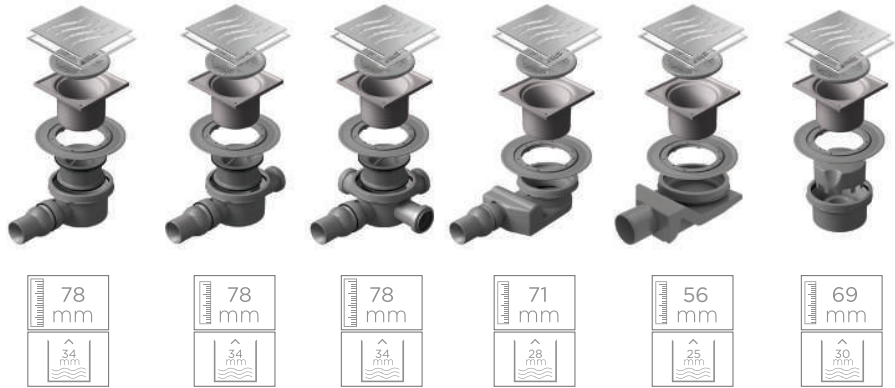

Optional Grid design

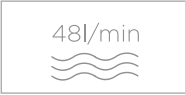
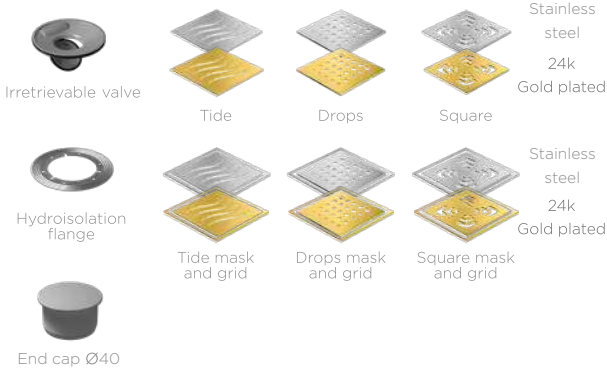

Maximum flow rate



Base diameter outlet



Base inlet diameter

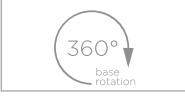

Base rotation



Handicapped accessible

Models with 10x10 grid

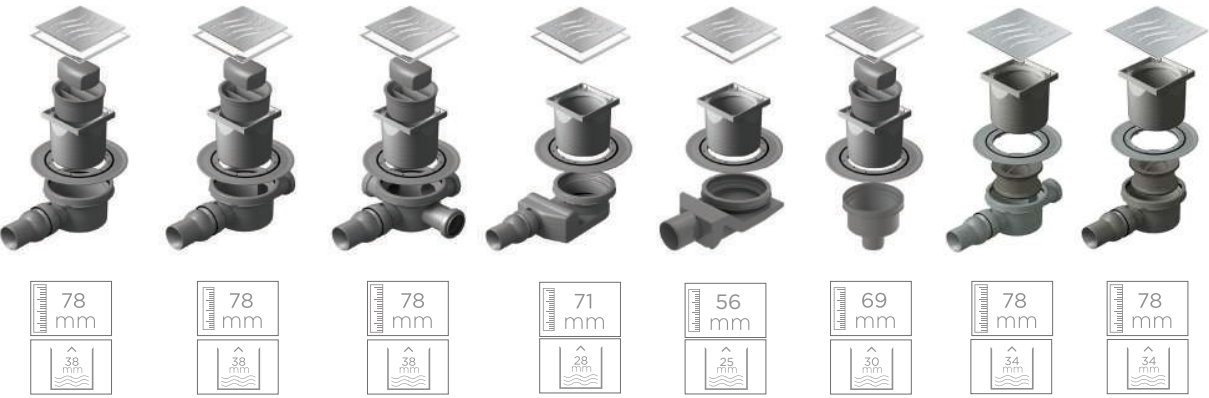

Grid design

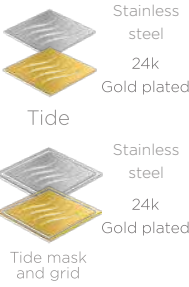

Fine output adjustment

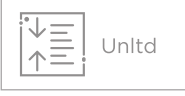

Ceramic adjustment



Material of grid



Confluo Standard Glass drains

Models with 15x15 grid

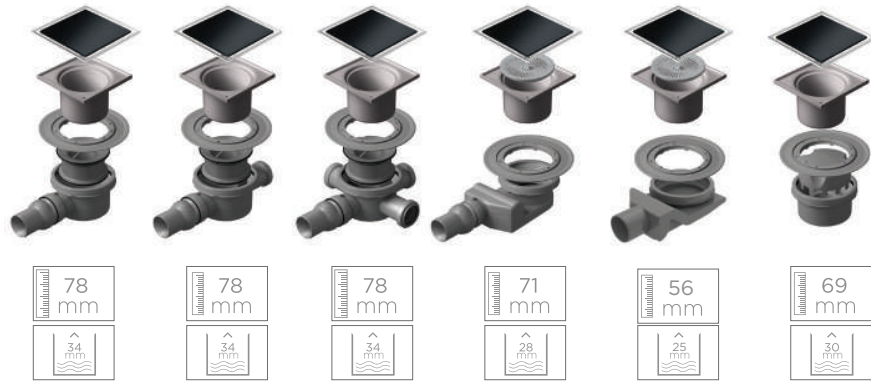

Models with 10x10 grid

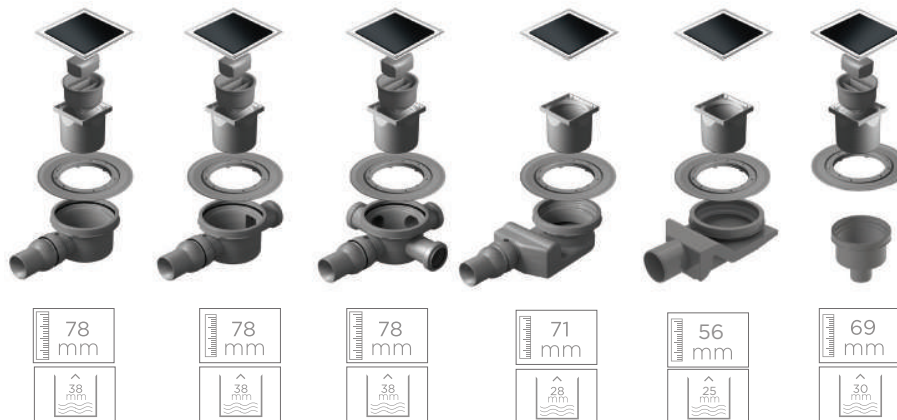

Optional



Grid design

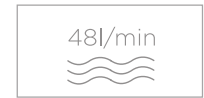
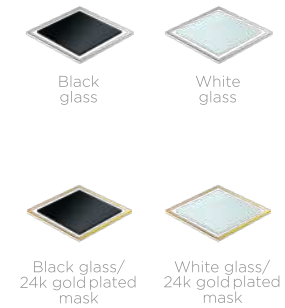

Maximum flow rate



Base diameter outlet



Base inlet diameter

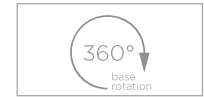

Base rotation



Handicapped accessible



Fine output adjustment

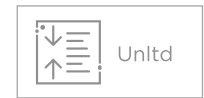

Ceramic adjustment



Confluo Standard Ceramic drains

Models with 15x15 grid

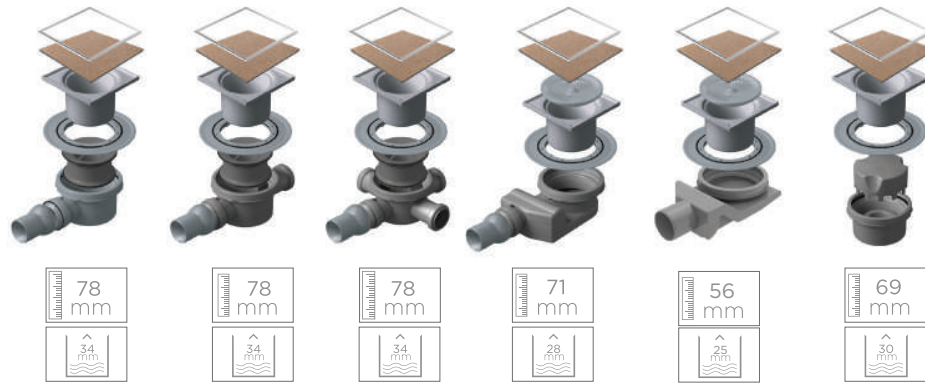

Models with 10x10 grid - Dry

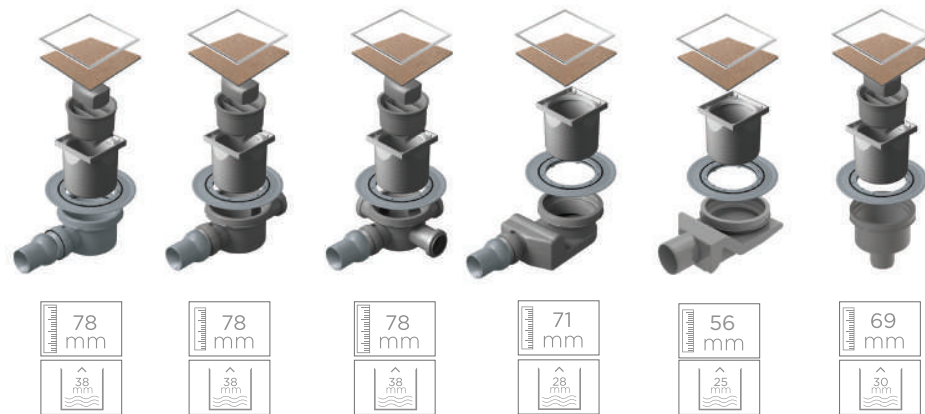

Optional



Grid design

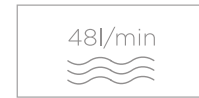
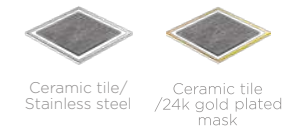

Maximum flow rate



Base diameter outlet



Base inlet diameter

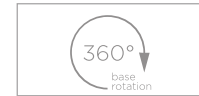

Base rotation



Handicapped accessible



Fine output adjustment



Ceramic adjustment

2 u 1 system
**ONE PRODUCT,
TWO DESIGNS**

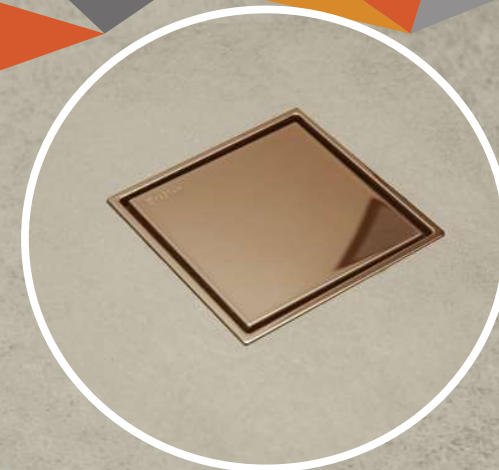

2 u 1 system
Coper

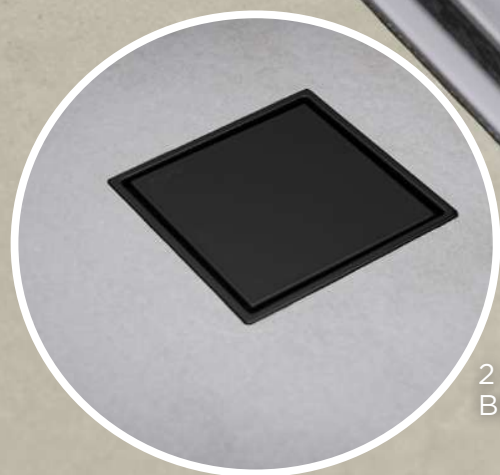

2 u 1 system
Black matt



2 u 1 system
Ceramic

Confluo Standard Plate 2 in 1

Models with 15x15 grid

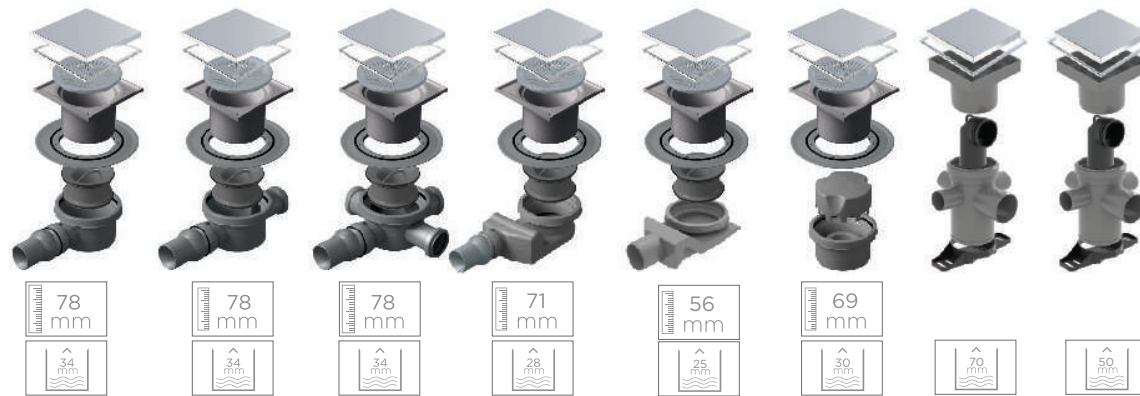

Optional

Grid design

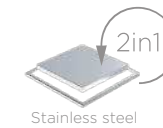

48l/min

Maximum flow rate

Ø50
output

Base diameter outlet

2 in 1
system

2 in 1 system

Ø40
inlet

Base inlet diameter

360°
base rotation

Base rotation



Handicapped accessible



Fine output adjustment



Ceramic adjustment

AISI 304

Material of grid

Models with 10x10 grid - Dry

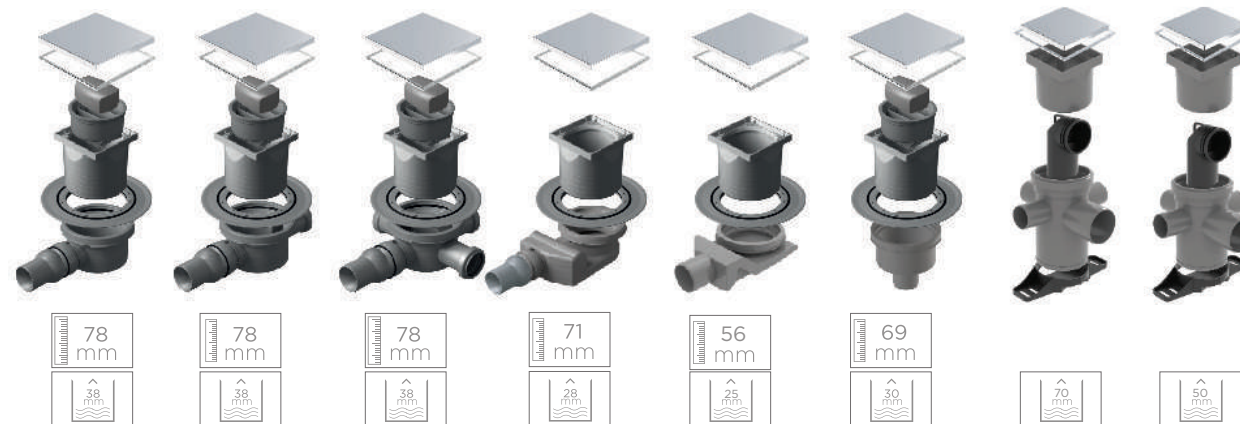



Confluo Standard Angle drains

Models with 20x20 grid



Optional



Grid design

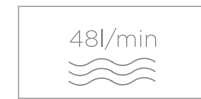

Maximum flow rate

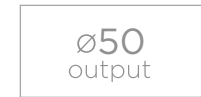

Base diameter outlet

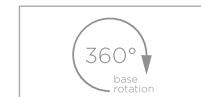

Base rotation



Handicapped accessible



Fine output adjustment



Ceramic adjustment



Material of grid



Confluo Primo models are a line of products specially made for mass distribution in DIYs and hardware shops all around the world. All the parts are coming in transparent blister packing and this is our line which fits most property common situations in the bathroom making it perfect for the customers who want good relation between design, price, and quality.

Confluo Primo

Main advantages:

- Minimum installation height — 52 mm
- Maximum flow rate — 48 l/min
- Reversible grid — 2 in 1 system
- 360° rotatable self-cleaning S base
- MAPEI waterproofing

Dimensions: 450, 550, 650, 750, 850 mm

Grid Design

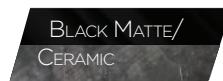



601105101

2 in 1 reversible grid
option with ceramic

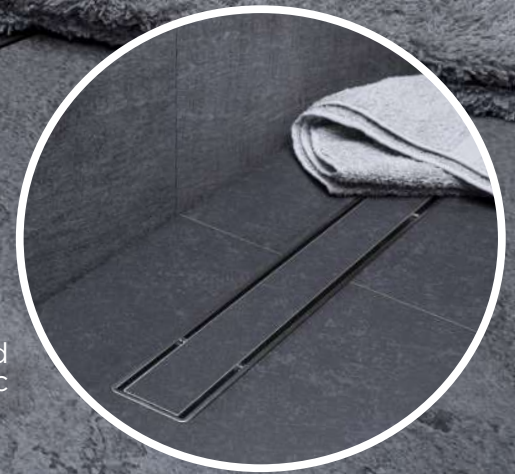

CONFLUO **COMPACT** LINE PRIMO

Compact Line
450 Primo

Compact Line
550 Primo

Compact Line
650 Primo

Compact Line
750 Primo

Compact Line
850 Primo



Also available with
Net grid

2in1

7

6

5

3

360°

8

1

4

2

Legend:

1. Ultra low S Base
2. Height adjustment legs
3. Reducer with rubber ring
4. Grid holder
5. Grid for hair
6. Mask
7. Grid, full metal
8. Mapei waterproofing butyl tape

52
mm

Min. installation height

48l/min

Maximum flow rate

2 in 1
system

2 in 1 system

SC

Self-cleaning base

K3

Load class of grid

50
output

Base diameter outlet

360°
base
rotation

Base rotation

25
mm

Water seal height

AISI 304

Material of grid

PRIMO



CONFLUO **COMPACT** LINE BLACK MATTE PRIMO

Compact BM
450 Primo

Compact BM
550 Primo

Compact BM
650 Primo

Compact BM
750 Primo

Compact BM
850 Primo



Legend:

1. Ultra low S Base
2. Height adjustment legs
3. Reducer with rubber ring
4. Grid holder
5. Grid for hair
6. Mask
7. Grid
8. Mapei waterproofing butyl tape

52
mm

Min. installation height

48l/min

Maximum flow rate

2 in 1
system

2 in 1 system

SC

Self-cleaning base

K3

Load class of grid

50
output

Base diameter outlet

360° base
rotation

Base rotation

25
mm

Water seal height

AISI 304

Material of grid

PRIMO



CONFLUO PRIMO LINE

Primo 450 Primo 550 Primo 650 Primo 750 Primo 850



Legend:

1. Ultra low S Base
2. Height adjustment legs
3. Reducer with rubber ring
4. Grid holder
5. Grid for hair
7. Grid
8. Mapei waterproofing butyl tape

52 mm

Min. installation height

48l/min

Maximum flow rate

2 in 1 system

2 in 1 system

SC

Self-cleaning base

K3

Load class of grid

50 output

Base diameter outlet

360° base rotation

Base rotation

25 mm

Water seal height

AISI 304

Material of grid

PRIMO

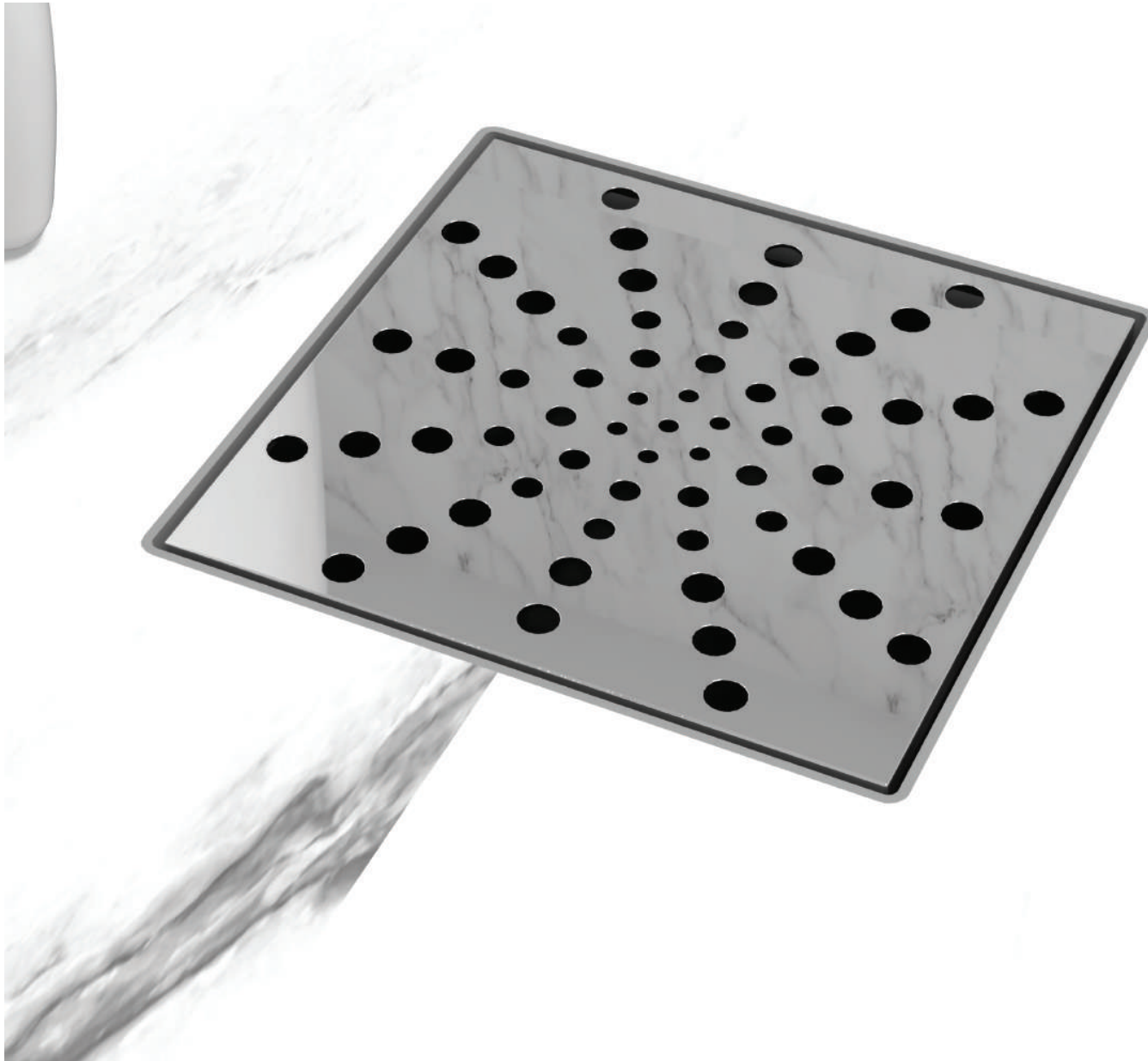

Primo Square stainless steel grid drain is manufactured in 150x150 mm grid size with 4 different types of outlet and polished stainless steel grid made from AISI 304. Primo Square plastic grid drain is manufactured in 150x150mm and 200x200 mm grid size with 5 different types of outlet and grid made from polypropylene.

Primo **Square** drains

Main advantages:

- Minimum installation height — 47-82 mm
- High flow rate
- Cost effective
- Easy to install product

Grid finish

STAINLESS STEEL

PLASTIC

Primo Uno



Primo Square Metal

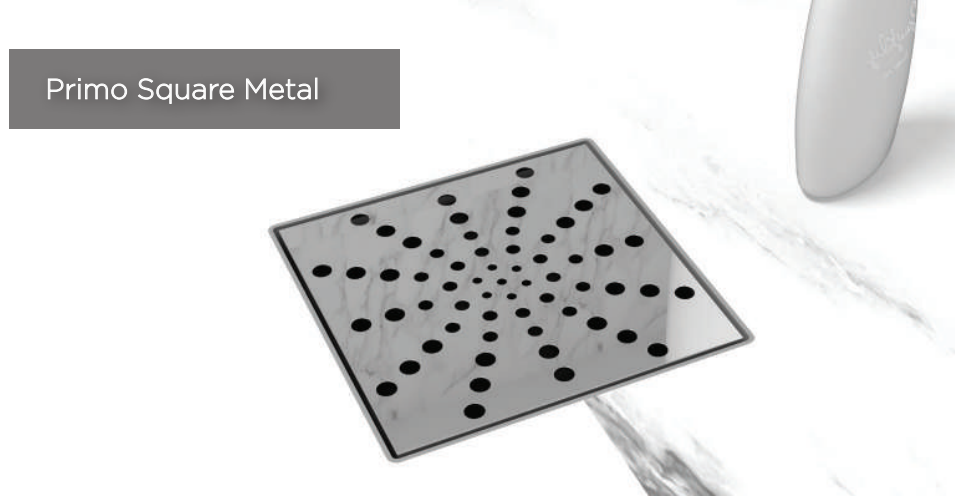

Primo Square Plastic



Primo Round Plastic



Primo Square drains

Models for bathroom 15x15 grid



Primo Uno Vertical

ø50
output ø75
output



Primo Uno Horizontal

ø50
output ø75
output

Models for garage 20x20 and 25x25 grid



Primo Square Plastic Vertical

ø50
output ø75
output



Primo Square Plastic Horizontal

ø50
output ø75
output



Primo Square Metal Vertical

ø50
output ø75
output



Primo Square Metal Horizontal

ø50
output ø75
output



Primo Round Plastic Vertical

ø110
output

Confluo POS Displays



Confluo
Big Display



Confluo
Combo Display



Confluo Single
Display **Premium**



Confluo Single
Display **Compact**



Confluo Single
Display **Frameless**



Confluo Single
Display **Slim**



Confluo Single
Display **Wall**

ADAPTERS

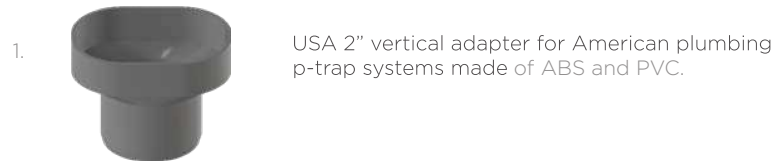

USA 2" vertical adapter for American plumbing p-trap systems made of ABS and PVC.

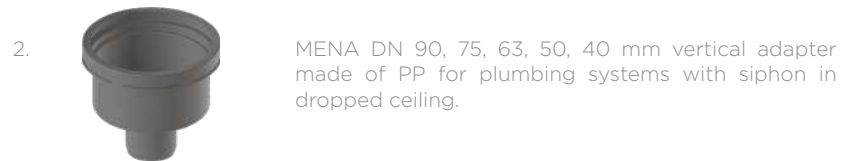

MENA DN 90, 75, 63, 50, 40 mm vertical adapter made of PP for plumbing systems with siphon in dropped ceiling.



MENA DN 50 MM VERTICAL ADAPTER



Mena DN 100 mm adapter

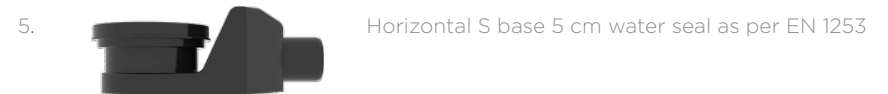

Horizontal S base 5 cm water seal as per EN 1253

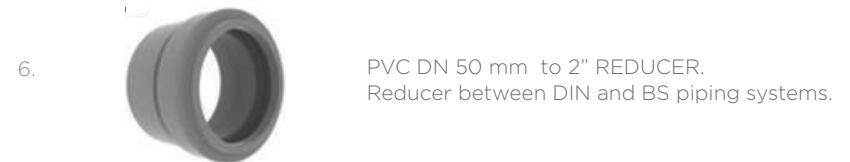



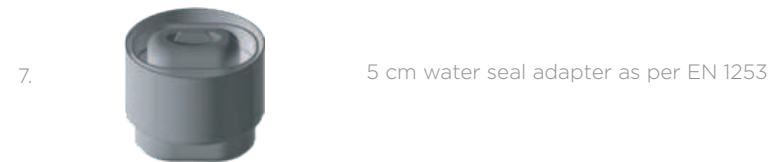



PVC DN 50 mm to 2" REDUCER.
Reducer between DIN and BS piping systems.



5 cm water seal adapter as per EN 1253

Compatibility of adapters with Confluo models:

	Confluo Premium Line	Confluo Compact Premium	Confluo Frameless Line	Confluo Slim Line	Confluo Wall Drain	Confluo Standard	Confluo Compact Primo
1. 	√	√	√	√	√		√
2. 	√	√	√	√	√	√	√
3. 	√	√	√	√	√		√
4. 	√	√	√	√	√		√
5. 	√	√	√	√	√		√
6. 	√	√	√	√	√	√	√
7. 	√	√	√			√	√



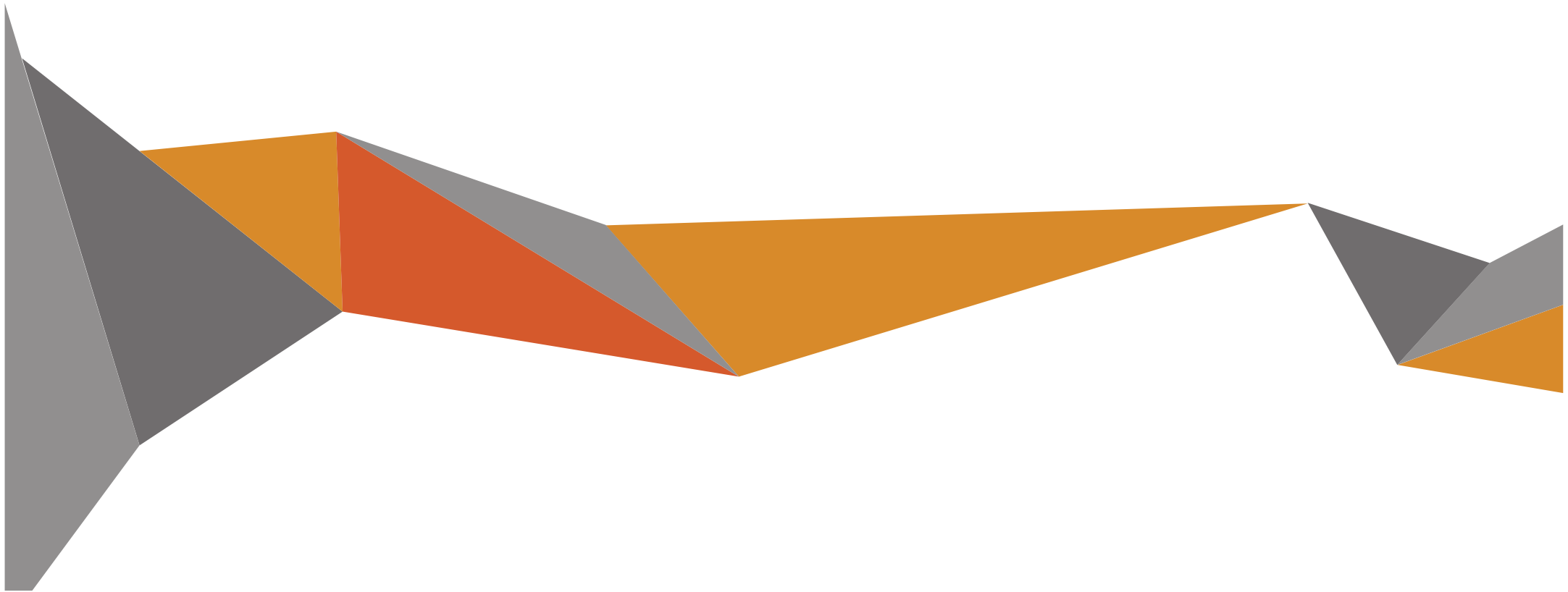

Fluenta





Fluenta concealed flushing cisterns are a perfect choice for furnishing bathrooms and sanitary facilities. An economical and noiseless flushing cisterns will ensure outstanding performance. A rich offer of flushing plates is aesthetically customized to match with the environment according to your wishes.

Fluenta

Concealed Flushing Cistern

Main advantages:

- Powder-coated metal construction, square profile 40 x 40 mm with pre-assembled concealed flushing cistern
- Frontal - dual flushing (3-6 l default, 4,5-9 l optional)
- Adjustable flushing volume (maximum quantity of water 6-9 l, a minimum quantity of water 3-4,5 l)
- Pre-assembled wall brackets and adjustable support legs (0-200 mm)
- Water connection possibility in two positions
- Fully insulated against condensation
- Silent mechanical filling valve (noise emission class 1 ISO 3822)
- Depth adjustable drain elbow (+/- 10 mm)



In touch
with elegance and modern
technology

Tehchnical information

Installation method

- Installation in prefabricated walls, pre-wall installation in dry walls, universal installation into solid walls
- Corner installation

The product contains

- Concealed flushing cistern with a pre-mounted angle valve
- Water connection 1/2"
- PE wall drain elbow $\varnothing 90/110$ mm with a seal
- All parts required for mounting and fixing of the product

Packaging

- Pallet: 24 pcs

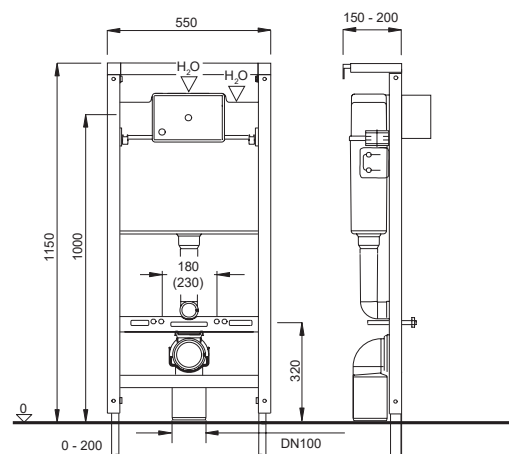

GUARANTEE
10
YEAR

10 year guarantee

SPARE PARTS
25
YEAR

25 year guarantee on
spare parts

400
kg

400 kg load capacity



Low noise



Easy to maintain



Dual flush



Tested 200.000 times



Fluenta Flushing Plates

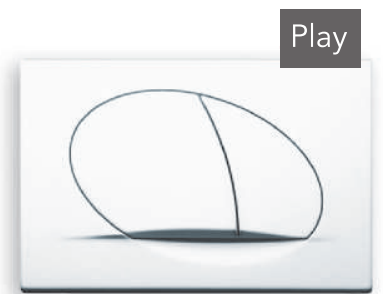

White



White



Shine Chrome



Shine Chrome



White



White



Brushed Chrome



Brushed Chrome



Black



Black



Fluenta FIT is a concealed flushing cistern with a depth of only 80 mm. Due to the dimensions, it is suitable for fitting in the limited space, whether it is equipping new bathroom or renovating the old one. Fluenta FIT has a strong metal construction (complete frame), and a silent hydraulic valve with a recognized NF certificate is for the rinsing. With great quality-price ratio, it is affordable and it fits into a limited budget, and elegant lines of flushing plates it fits perfectly in the modern designed bathroom.

Fluenta Fit

Concealed Flushing Cistern

Main advantages:

- Installation depth 80 mm;
- Supporting frame tested according NF Standards (XP D12-208), tested at 400 kg, cathoresis application against corrosion, 200 hours of resistance to salt spray, with adjustable feet;
- Dual flush volume adjustable; small quantity: 2,5 - 4/big quantity: 3 - 6 L;
- Styrofoam insulation against condensation;
- Silent hydraulic fill valve - Class II, EN 14124;
- Each cistern is tested individually in the works;
- Pre-assembled discharge elbow Ø90 mm with reducer Ø110 mm or Ø100 mm;
- Clip-on collar to simplify the attachment of the pipe to the frame;
- Including connecting sleeves for pan inlet and outlet with protective caps, built-in protection box for mortar, fixing materials.



80 mm

INSTALLATION
DEPTH

Tehchnical information

Installation method

- Installation in prefabricated walls, pre-wall installation in dry walls, universal installation into solid walls.

The product contains:

- Concealed flushing cistern with a pre-mounted angle valve;
- Water connection 1/2";
- PE wall drain elbow Ø90/110 mm with a seal;
- All parts required for mounting and fixing of the product.

Packaging:

- Pallet: 24 pcs

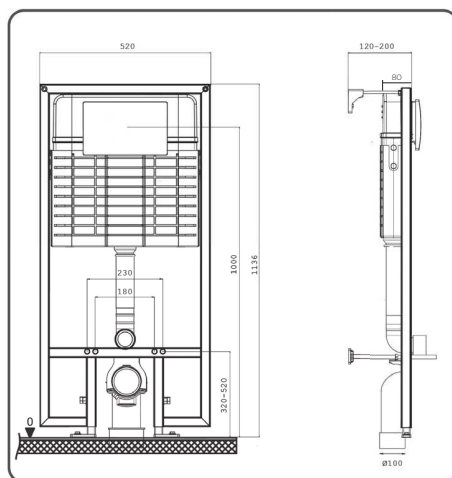

GUARANTEE

5
YEAR

5 year guarantee

400
kg

400 kg load capacity

80 mm

80 mm ultra thin



Low noise

Ø
90/110

Outlet

2,5/4 L
3/5 L

Dual flush

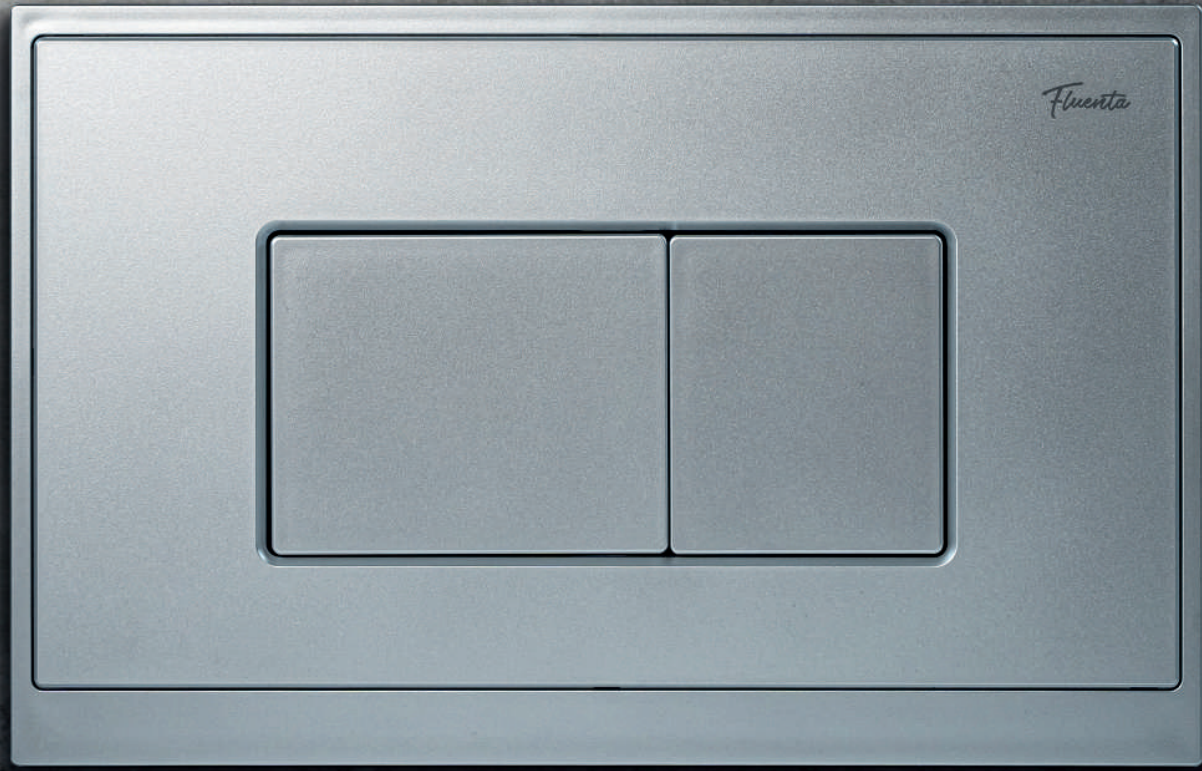

Fluenta Fit Flushing Plates

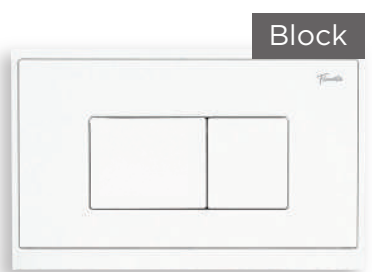

White

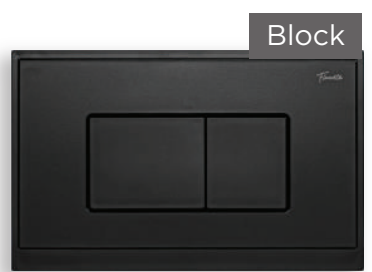

Black

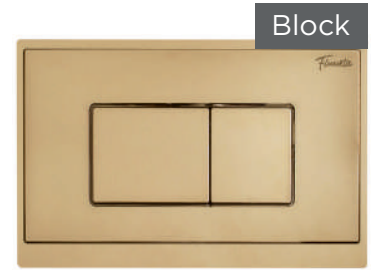

Coper

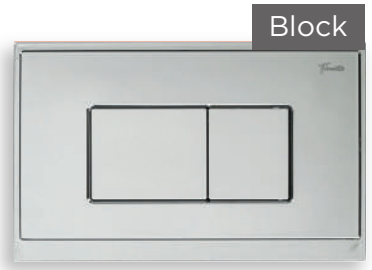

Shine Chrome

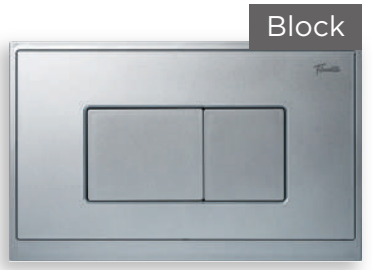

Brushed Chrome



White



Shine Chrome



Brushed Chrome



Black



Fluenta **Bidet** concealed element

Installation method:

- Installation in both solid and drywalls
- Concealed element height: 115 cm
- Concealed element width: 50 cm
- For installation of wall-hung bidet with an axial distance of 18 or 23 cm
- Supporting frame made from 40 × 40 mm profiles, surface protected with powder coating
- Support legs - ranging from 0 to 24 cm
- Range of brackets for pre-wall installation: from 12 to 20 cm

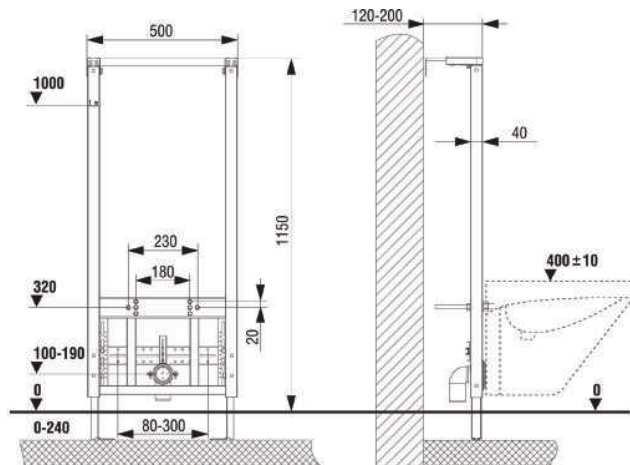



Fluenta Rimless Wall Hung Toilet Bowl with elegant and modern design without visible mounting parts ideally fits into your modern bathroom. Fluenta Rimless is a Wall Hung Toilet Bowl that ideally fits with our Fluenta concealed flushing cistern. Innovative rimless flushing technology completely disables retention of bacteria and impurities below the inner edge. With modern and elegant design, Fluenta toilet seat have "soft-close" mechanism for slowing down the seat, which prevents accidental drops of seat, shocks or injuries.

Fluenta **Rimless** Wall Hung Toilet Bowl

Main advantages:

- Ultra-thin duroplast soft close toilet seat is included;
- Rimless flushing technology completely disables retention of bacteria and impurities below the inner edge;
- Mounting set for easy installation is included;
- No visible syphon and mounting parts.

Dimensions: L 555 mm, W 370 mm, H 354 mm



„Soft close” toilet seat
made from Duroplast.

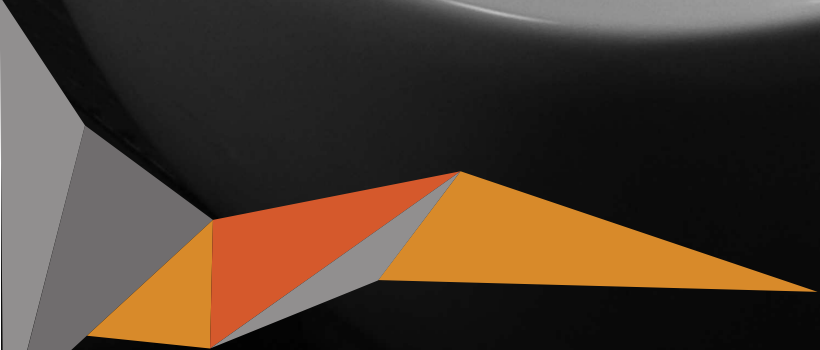

Fluenta **Rimless** Wall Hung Toilet Bowl

Elegance

Elegant design with modern shape and reduced lines, without visible mounting parts, will fit ideally into your modern bathroom

Easy maintenance and cleaning

Innovative rimless toilet bowl flushing technology completely disables retention of bacteria and impurities below inner edges.

Ultra slim “soft close” toilet seat

With modern and elegant design, Fluenta toilet seat have “soft close” mechanism, which prevents fast closing, noise, impacts or injuries.

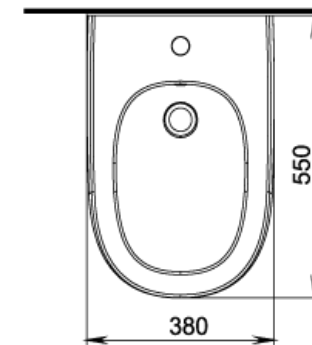
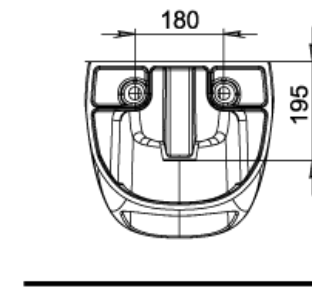
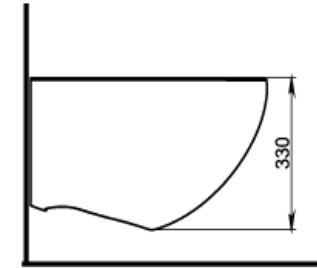



Fluenta **Basic** Wall Hung Toilet Bowl

Fluenta Basic console toilet bowl perfectly fits with its simple design to the Fluenta concealed flushing cisterns and together they make an elegant and functional solution. It is made of a material with exceptional strength, resistant to damage, and easy to clean. Fluenta Basic toilet bowl is available with Classic or Click toilet seat. The Classic toilet seat has a soft-close mechanism for the slow lowering of the hoop and toilet seat without user intervention. The Click toilet seat has a soft-close mechanism for slow lowering and a button that allows easy removal of the toilet seat when you need to clean it.

Both these variants are made of the same material and have exceptional performance in terms of quality, design, and aesthetics. These products are delivered with all elements for quick and easy installation.



**BASIC WC TOILET BOWL
WITH CLASSIC TOILET SEAT**



**BASIC WC TOILET BOWL
WITH CLICK TOILET SEAT**

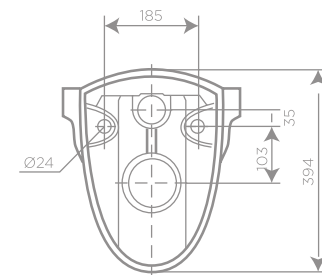
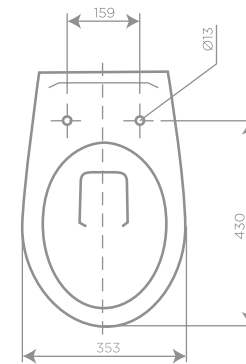
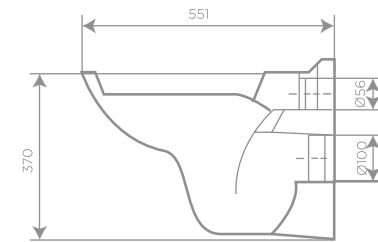



Designed to meet high criteria in terms of functionality and aesthetics.

Quality finishing with pleasant lines of minimalistic design makes Fluenta surface-mounted washbasin a part of perfect harmony with other Fluenta elements for your modern bathroom which exudes elegance.

Fluenta **Surface-mounted** Washbasin

Main advantages:

- Scratch resistance surface
- Glossy finish
- Slim design
- No-Spill function





Fluenta **Round** Washbasin

Dimensions: L 615 mm, W 360 mm, H 115 mm

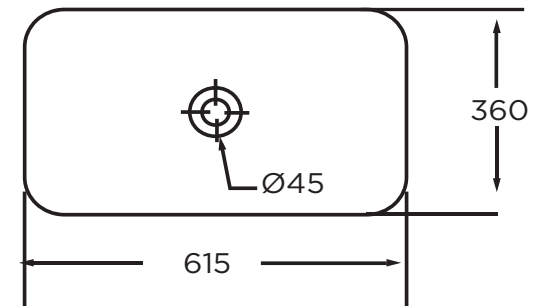

Fluenta **Round mini** Washbasin

Dimensions: L 500 mm, W 360 mm, H 115 mm

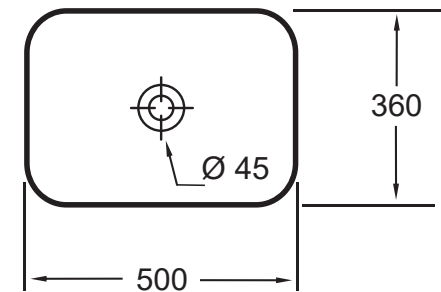
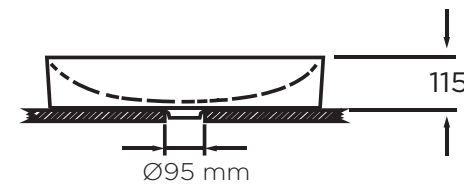

A decorative graphic element in the top left corner consisting of several overlapping triangles in shades of grey, orange, and yellow, pointing towards the right.

The Fluenta Spot sink is an unmistakable choice for smaller bathrooms, affordable and easy to fit, and will complete the space according to your taste. With an elegant and modern design, natural lines made of the finest porcelain, it fits perfectly with other Fluenta products. A spot sink with an interesting shape can be a special detail even in a simply decorated space.

A close-up photograph of the Fluenta Spot sink, a white porcelain spot sink with a circular drain, resting on a dark wooden surface. The brand name 'Fluenta' is visible in a cursive font on the rim of the sink.

Fluenta

Fluenta **Spot** Washbasin

Dimensions: Ø380 mm, H 115 mm

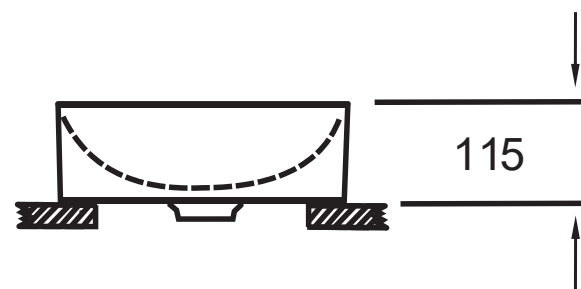
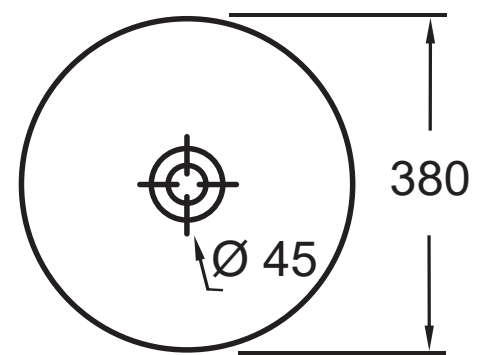

CONTENT

03	WE ARE	71	CONFLUO STANDARD ANGLE
07	BATHROOM SOLUTIONS	73	CONFLUO PRIMO LINE MODELS BENEFITS
09	CONFLUO	75	CONFLUO COMPACT LINE PRIMO
10	ICONS	77	CONFLUO COMPACT LINE BLACK MATTE PRIMO
11	CONFLUO MODELS	79	CONFLUO PRIMO LINE
13	ULTRA LOW S BASE	81	PRIMO SQUARE DRAINS
15	CONFLUO PREMIUM LINE	84	POS DISPLAYS
23	CONFLUO COMPACT LINE PREMIUM	85	WEBSHOP
31	ANTI-LEAKING SYSTEM	87	ADAPTERS
33	CONFLUO FRAMELESS LINE	89	FLUENTA
43	CONFLUO SLIM LINE	91	FLUENTA CONCEALED FLUSHING CISTERN
47	WALL DRAIN	95	FLUENTA FLUSHING PLATES
53	CONFLUO BOARD	97	FLUENTA FIT CONCEALED FLUSHING CISTERN
59	CONFLUO STANDARD	101	FLUENTA FIT FLUSHING PLATES
63	CONFLUO STANDARD WITH METAL GRID	103	FLUENTA BIDET CONCEALED ELEMENT
65	CONFLUO STANDARD GLASS	105	FLUENTA RIMLESS WALL HUNG TOILET BOWL
67	CONFLUO STANDARD CERAMIC	109	FLUENTA BASIC WALL HUNG TOILET BOWL
69	CONFLUO STANDARD PLATE 2 IN 1	111	FLUENTA SURFACE-MOUNTED WASHBASIN

По вопросам продаж и поддержки обращайтесь:

Алматы (7273)495-231
Ангарск (3955)60-70-56
Архангельск (8182)63-90-72
Астрахань (8512)99-46-04
Барнаул (3852)73-04-60
Белгород (4722)40-23-64
Благовещенск (4162)22-76-07
Брянск (4832)59-03-52
Владивосток (423)249-28-31
Владикавказ (8672)28-90-48
Владимир (4922)49-43-18
Волгоград (844)278-03-48
Вологда (8172)26-41-59
Воронеж (473)204-51-73
Екатеринбург (343)384-55-89

Иваново (4932)77-34-06
Ижевск (3412)26-03-58
Иркутск (395)279-98-46
Казань (843)206-01-48
Калининград (4012)72-03-81
Калуга (4842)92-23-67
Кемерово (3842)65-04-62
Киров (8332)68-02-04
Коломна (4966)23-41-49
Кострома (4942)77-07-48
Краснодар (861)203-40-90
Красноярск (391)204-63-61
Курск (4712)77-13-04
Курган (3522)50-90-47
Липецк (4742)52-20-81

Магнитогорск (3519)55-03-13
Москва (495)268-04-70
Мурманск (8152)59-64-93
Набережные Челны (8552)20-53-41
Нижегород (831)429-08-12
Новокузнецк (3843)20-46-81
Ноябрьск (3496)41-32-12
Новосибирск (383)227-86-73
Омск (3812)21-46-40
Орел (4862)44-53-42
Оренбург (3532)37-68-04
Пенза (8412)22-31-16
Петрозаводск (8142)55-98-37
Псков (8112)59-10-37
Пермь (342)205-81-47

Ростов-на-Дону (863)308-18-15
Рязань (4912)46-61-64
Самара (846)206-03-16
Санкт-Петербург (812)309-46-40
Саратов (845)249-38-78
Севастополь (8692)22-31-93
Саранск (8342)22-96-24
Симферополь (3652)67-13-56
Смоленск (4812)29-41-54
Сочи (862)225-72-31
Ставрополь (8652)20-65-13
Сургут (3462)77-98-35
Сыктывкар (8212)25-95-17
Тамбов (4752)50-40-97
Тверь (4822)63-31-35

Тольятти (8482)63-91-07
Томск (3822)98-41-53
Тула (4872)33-79-87
Тюмень (3452)66-21-18
Ульяновск (8422)24-23-59
Улан-Удэ (3012)59-97-51
Уфа (347)229-48-12
Хабаровск (4212)92-98-04
Чебоксары (8352)28-53-07
Челябинск (351)202-03-61
Череповец (8202)49-02-64
Чита (3022)38-34-83
Якутск (4112)23-90-97
Ярославль (4852)69-52-93

Россия +7(495)268-04-70

Казахстан +7(7172)727-132

Киргизия +996(312)96-26-47

почта: pad@nt-rt.ru || сайт: <https://pestan.nt-rt.ru/>